

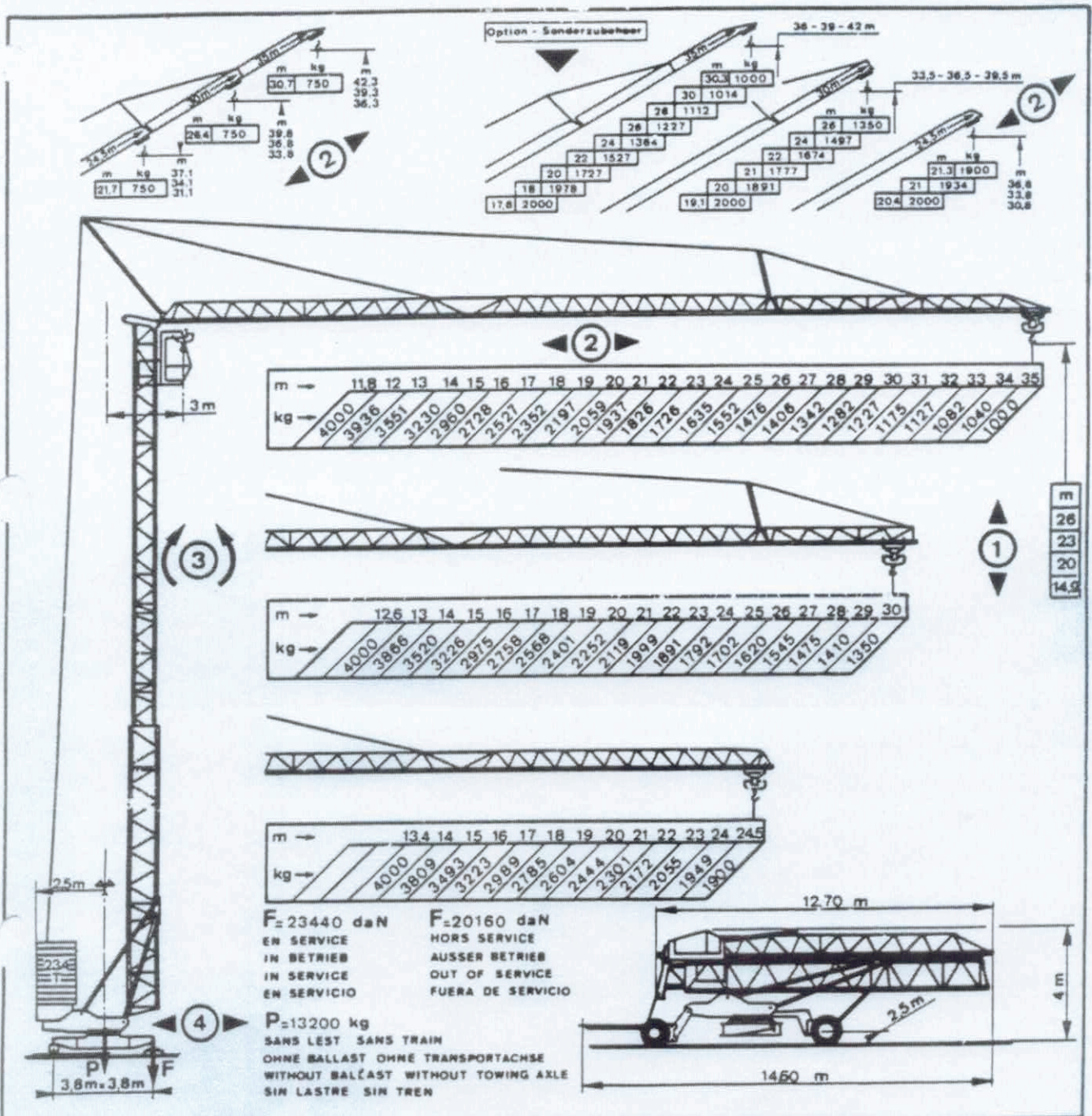













Potain 331B

PC – RCV

#74931

1994



50Hz  60Hz 		kg	m/mn		kW	380V - 50Hz = 20KVA 440V 60Hz = 24KVA	
15 TDPC10			4 000	4.15 / 4.9	3.7		22-44 m/mn / 3kW
			2 000	8.3 / 9.9	4.4		26-52 m/mn / 3.6kW
			4 000	12.5 / 15	11		0 → 0.81 tr/mn / 2.2 kW
			2 000	25 / 30	13.2		0 → 0.96 tr/mn / 2.2 kW
			2 000	25 / 30	11		25 m/mn / 2 = 1.5 kW
			1 000	50 / 60	13.2		30 m/mn / 2 = 1.8 kW

SUBJECT TO MODIFICATION

48V

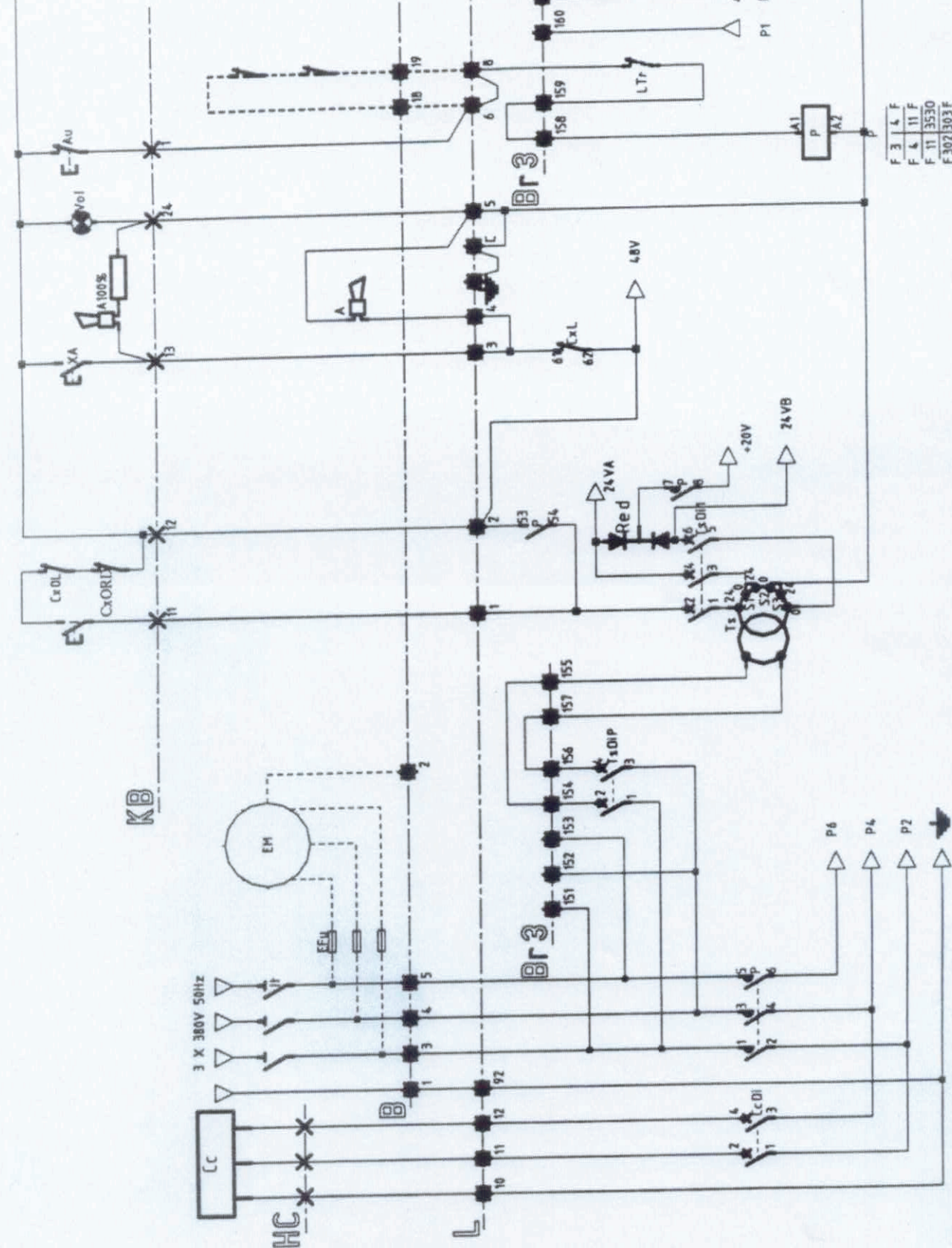

F.3	L.F
F.4	11 F
F.11	3530
F.302	303F

0100 038 7

CR5 4349F1E

1 | 2 | 3 | 4 | 5 | 6 | 7 | 8 | 9 | 10 | 11 | 12 | 13 | 14 | 15 | 15 | 17 | 18 | 19 | 20

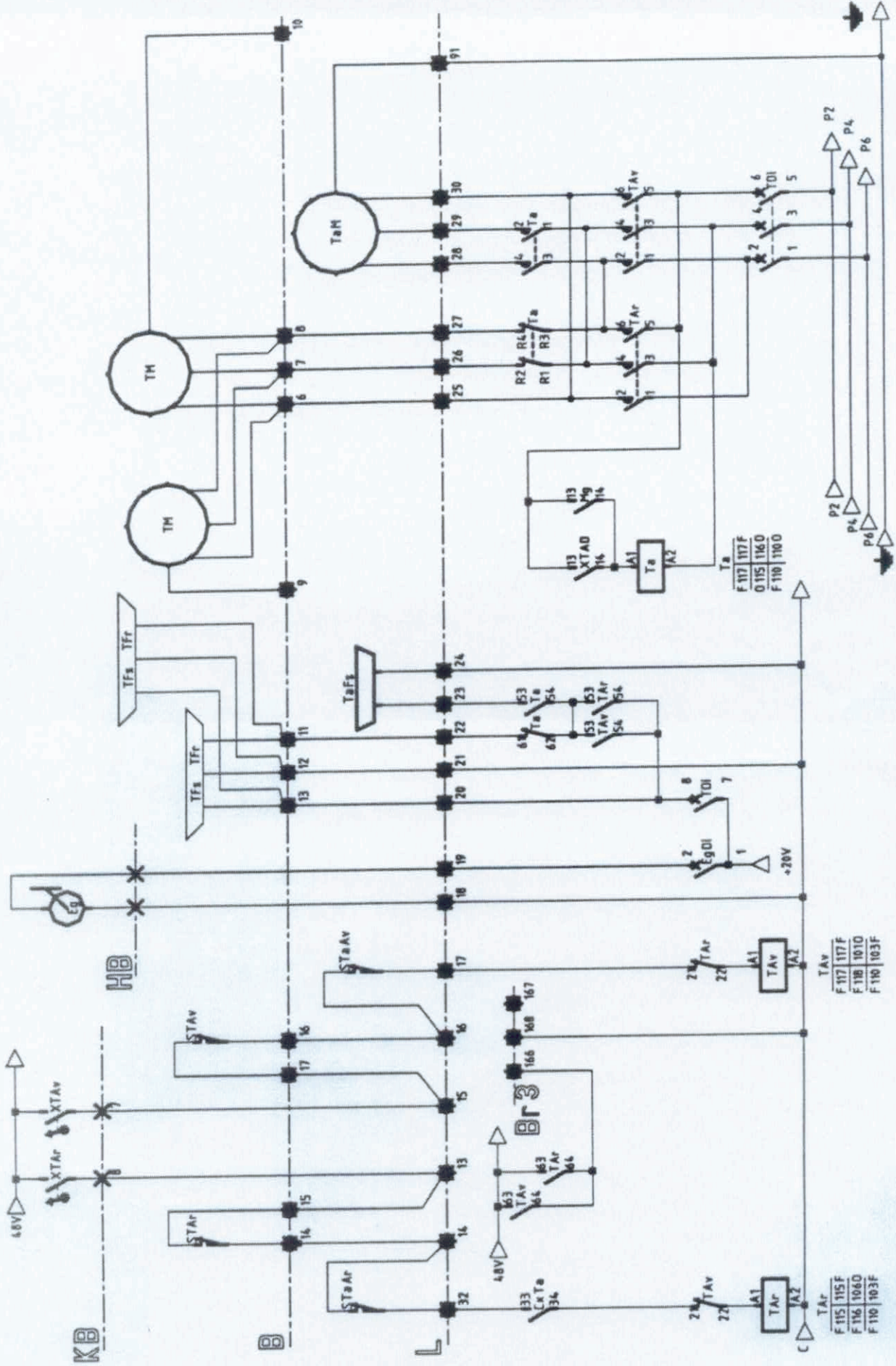

101 | 102 | 103 | 104 | 105 | 105 | 107 | 108 | 109 | 110 | 111 | 112 | 113 | 114 | 115 | 116 | 117 | 118 | 119 | 120

0110 033 7

CR5 4349F2E

48V 50Hz

KB

0120 088 1

CR5 4349F4E

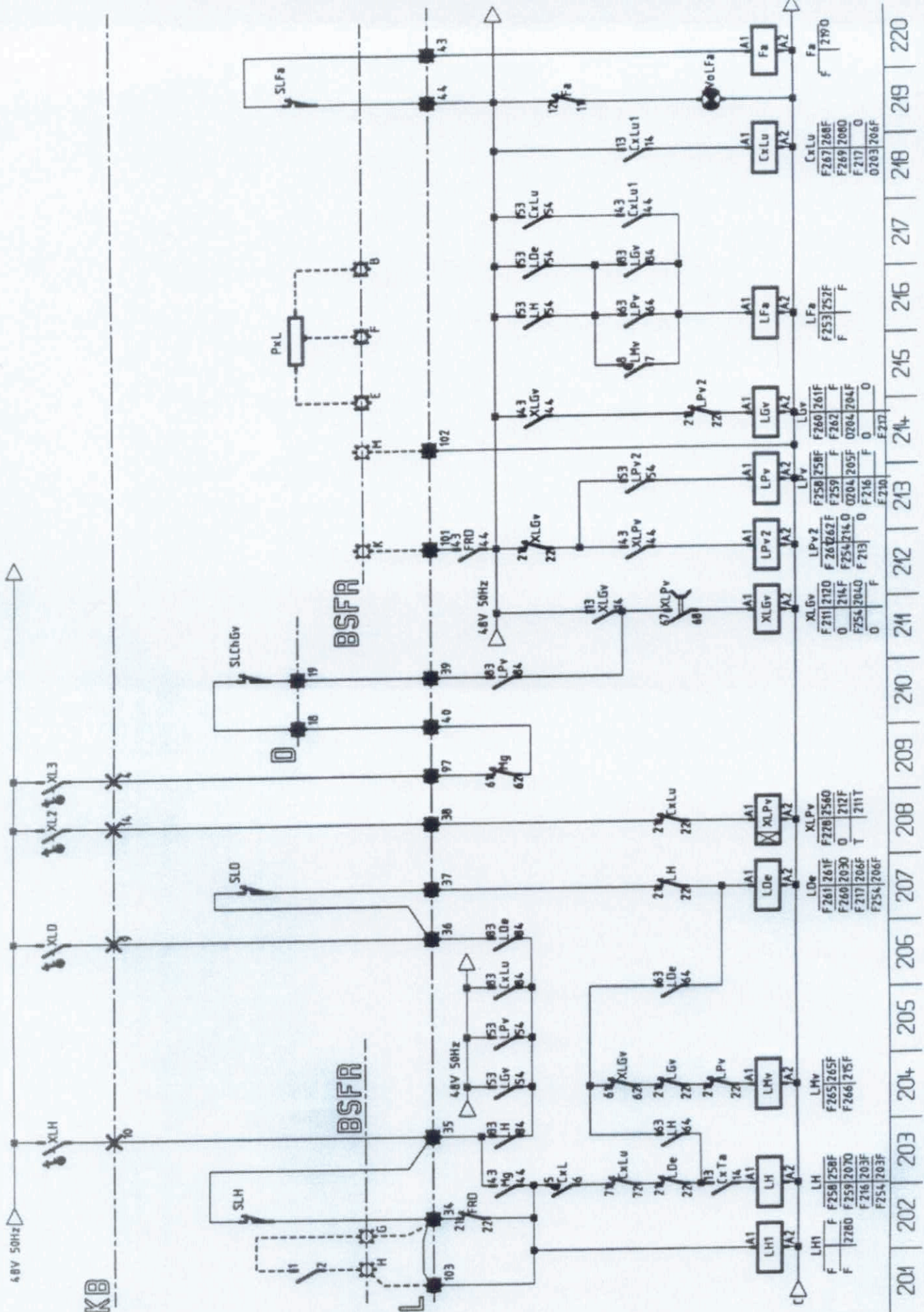

Fa	F2790	219
CxLu	F267/268F	218
F	F269/268O	217
F	F217	216
F	0703/266F	215
LFa	F253/252F	214
F	F	213
F	F	212
F	F	211
F	F	210
F	F	209
F	F	208
F	F	207
F	F	206
F	F	205
F	F	204
F	F	203
F	F	202
F	F	201

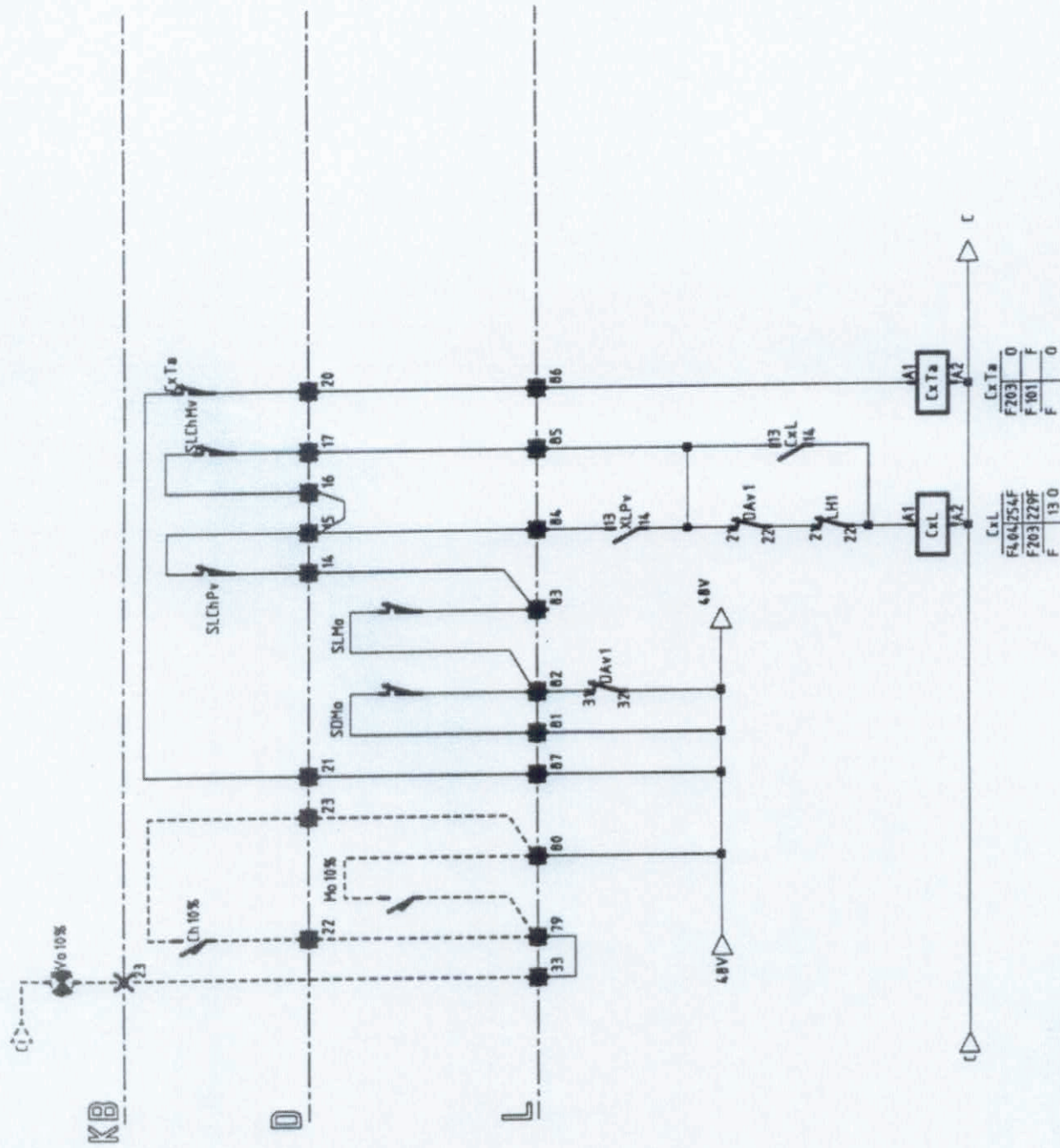

0122 012 3

CR5 4349F3E

221 | 222 | 223 | 224 | 225 | 226 | 227 | 228 | 229 | 230 | 231 | 232 | 233 | 234 | 235 | 236 | 237 | 238 | 239 | 240

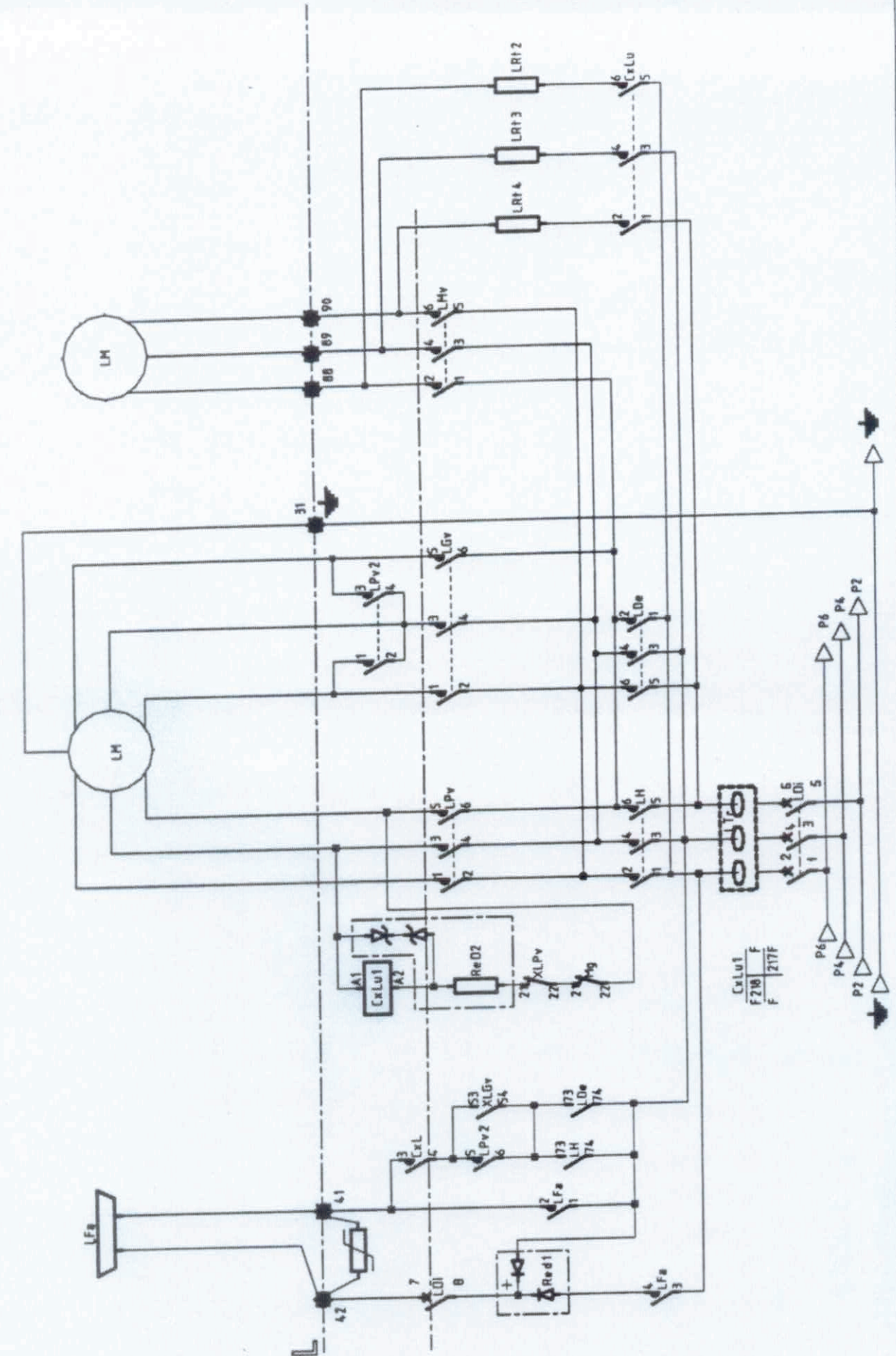

48V-50Hz
E-7 XRF's

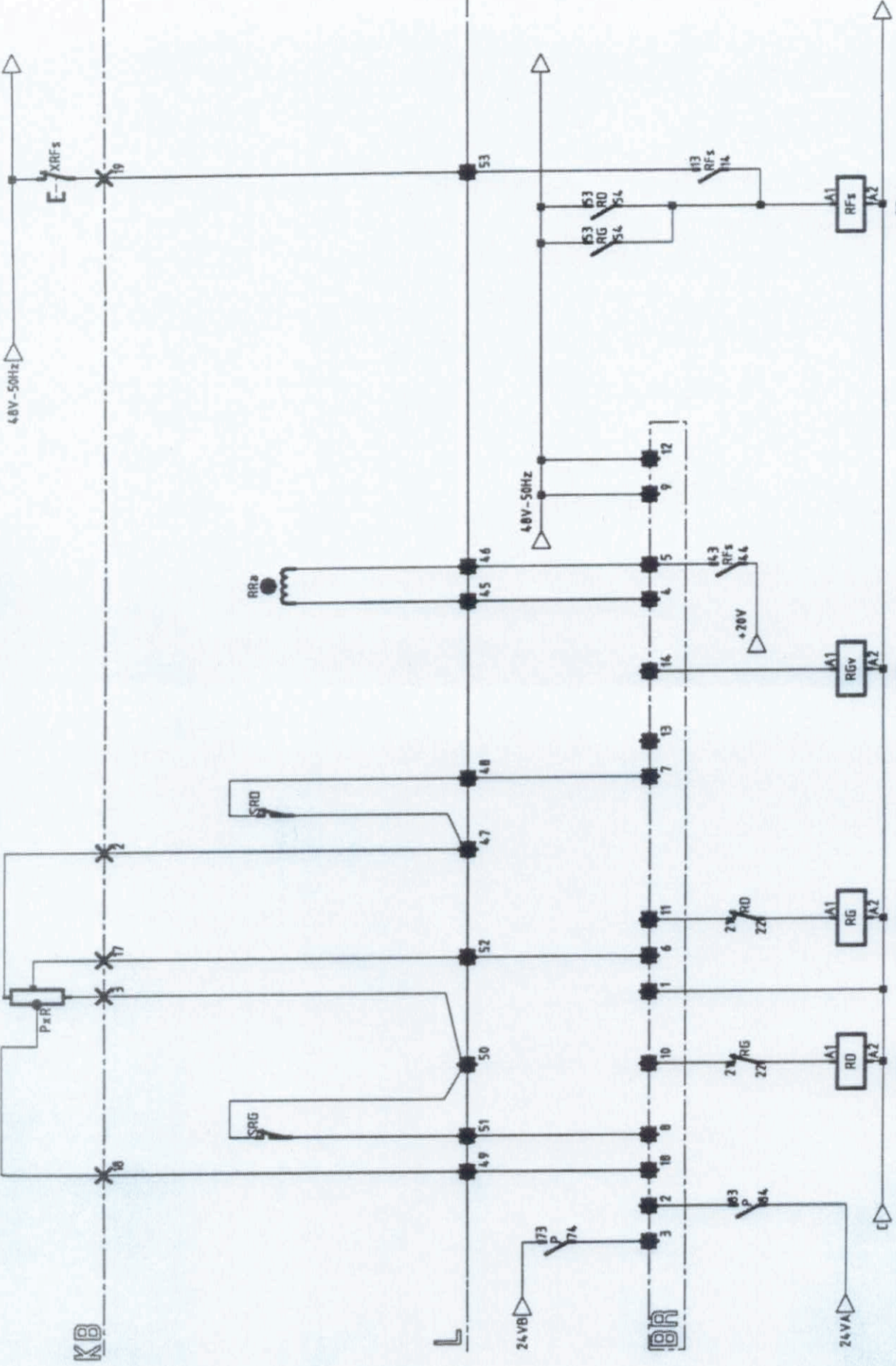

KB

BR

RF's	RGV	RG	RD
F317 0	F362/363F	F365/366F	F362/363F
F354/312F	F364 0	F367/3050	F364 3070
		F316 F	F317 F

0130 022 6

CR5 4349F6E

10E | 20E | 30E | 40E | 50E | 90E | 70E | 80E | 60E | 01E | 31E | 32E | 33E | 34E | 35E | 36E | 37E | 38E | 39E | 40E

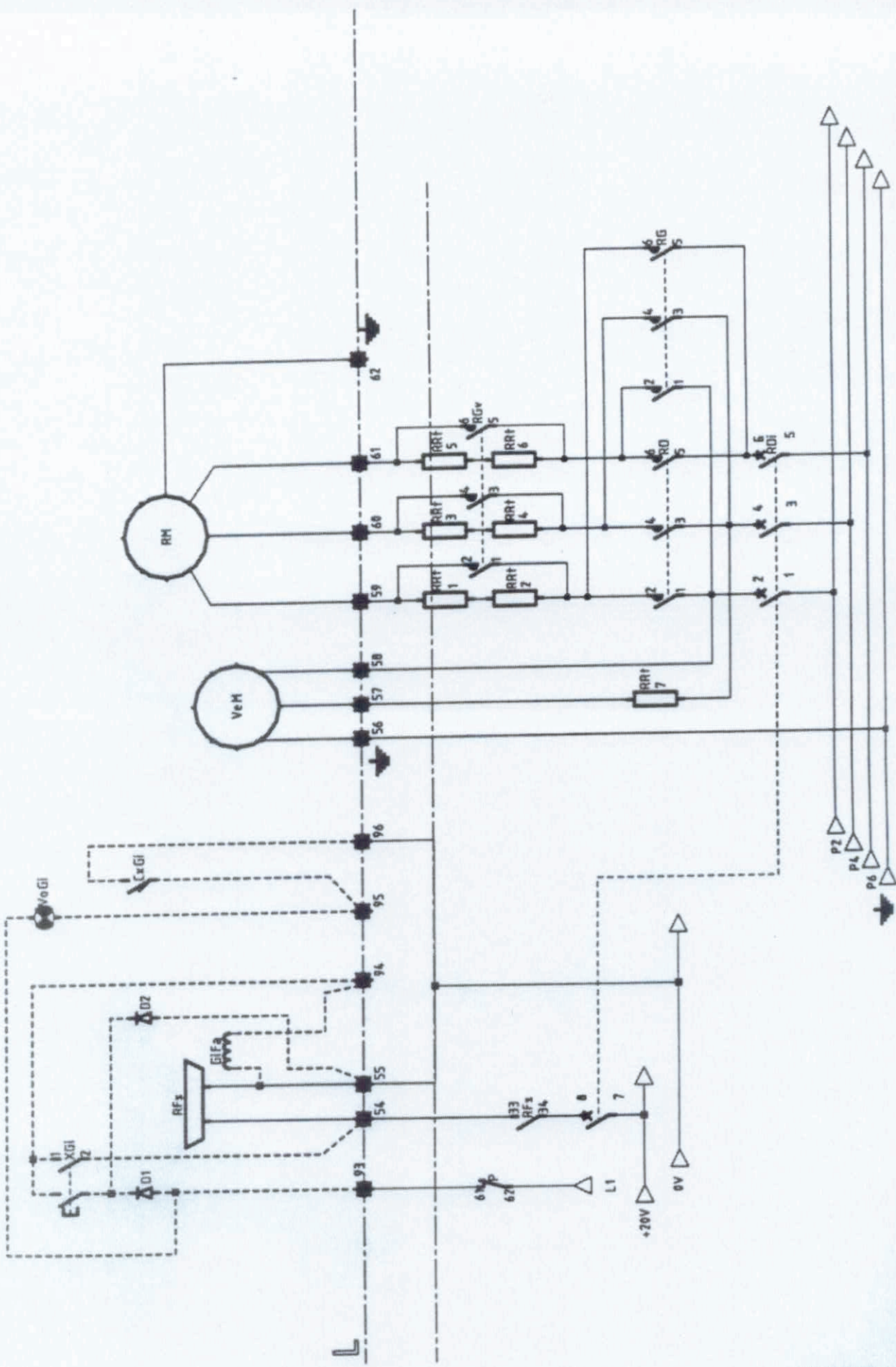

351 | 352 | 353 | 354 | 355 | 356 | 357 | 358 | 359 | 360 | 361 | 362 | 363 | 364 | 365 | 366 | 367 | 368 | 369 | 370

0135 024 5

CR5 4349F7E

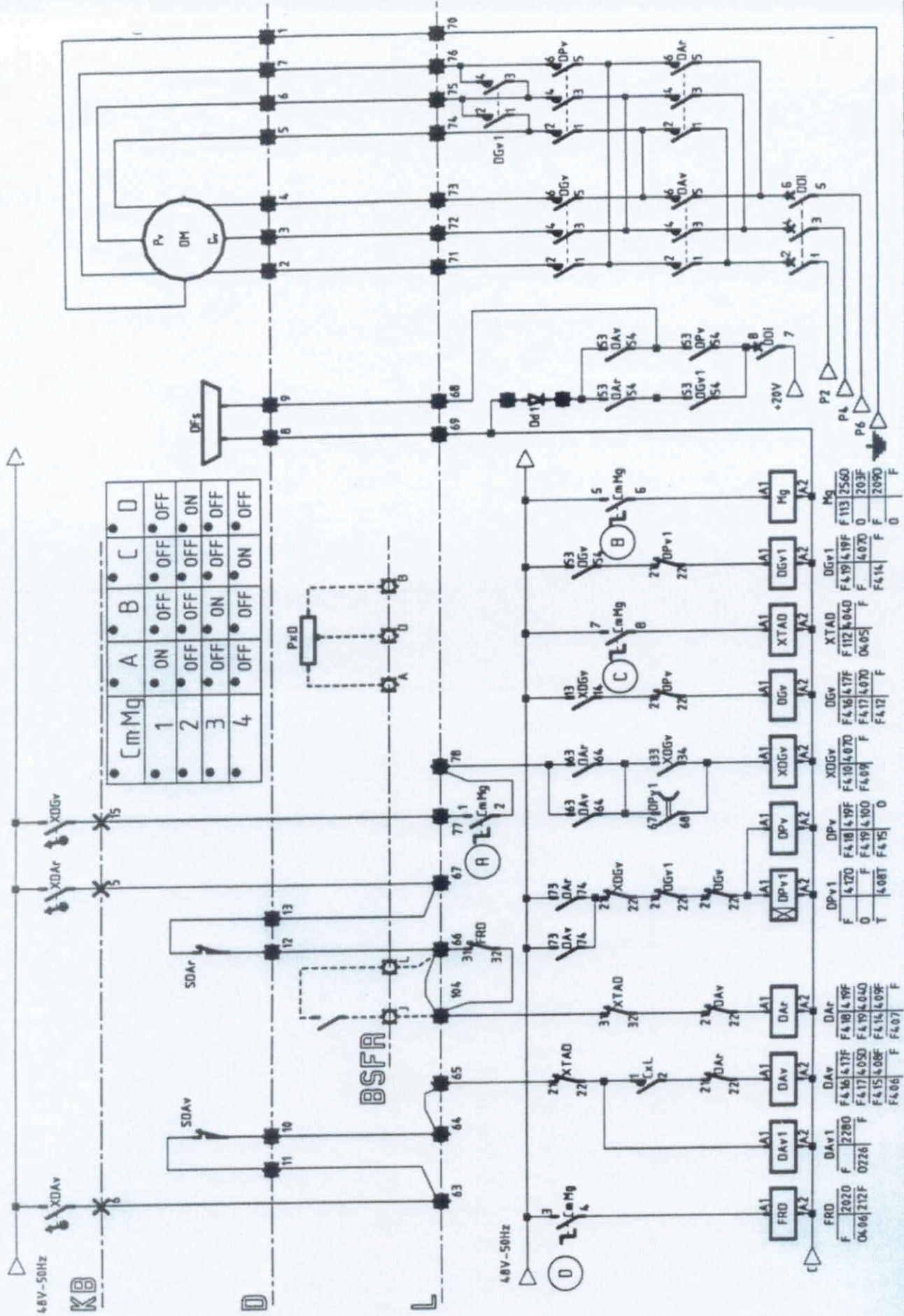

CmMg	A	B	C	D
1	ON	OFF	OFF	OFF
2	OFF	OFF	OFF	ON
3	OFF	ON	OFF	OFF
4	OFF	OFF	ON	ON

0140 094 2

CR5 4349F8E

401 402 403 404 405 406 407 408 409 410 411 412 413 414 415 416 417 418 419 420

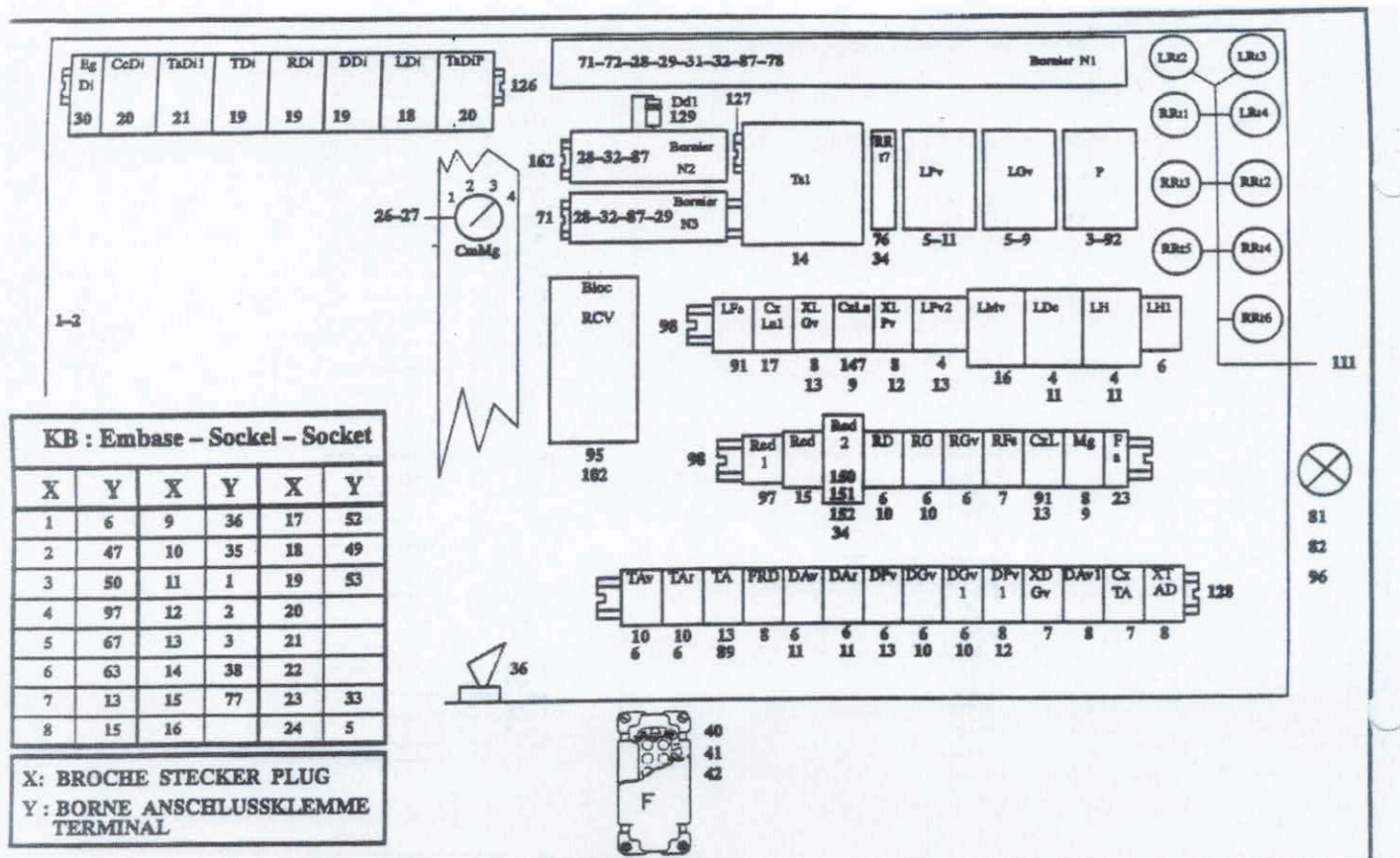

REP	REFERENCE	QTE	S	DESIGNATION	BEZEICHNUNG	DESCRIPTION	DESIGNACION
	L-66410-30			ARMOIRE PC15+P+RCV+D+T	SCHALTSCHRANK	CONTROL-PANEL	ARMARIO
01	M-65410-73	1		Armoire 1525x780x300	Schaltschrank	Control-panel	Armario
02	P-58410-93	1		Platine arm 331	Schrankmontageplatte	Panel fixing plate	Quadro armario
03	L-27411-73	1		Contacteur 4x40a b48v	Kontaktgeber	Switch	Contacteur
03A	D-33411-44	1		Bobine 48v (40-95a)	Spule	Coil	Bobina
04	A-27411-63	3		Contacteur 3x25a+o b48v	Kontaktgeber	Switch	Contacteur
04A	E-33411-45	3		Bobine 48v (25-32a)	Spule	Coil	Bobina
05	C-27411-65	2		Contacteur 3x40a+o+f b48v	Kontaktgeber	Switch	Contacteur
05A	D-33411-44	2		Bobine 48v (40-95a)	Spule	Coil	Bobina
06	V-27411-59	11		Contacteur 3x12a+o b48v	Kontaktgeber	Switch	Contacteur
06A	C-33411-43	11		Bobine 48v 50/60hz	Spule	Coil	Bobina
07	P-27411-76	3		Relais-aux 3f+1o b48v	Hilfsrelais	Auxiliary relay	Rele auxiliar
07A	C-33411-43	3		Bobine 48v 50/60hz	Spule	Coil	Bobina
08	D-28411-47	7		Relais-aux 2f+2o b48v	Relais	Relay	Rele
08A	C-33411-43	7		Bobine 48v 50/60hz	Spule	Coil	Bobina
09	F-04411-45	3		Bloc contacts 2f+20 front	Block	Block	Bloque
10	F-04411-68	6		Bloc contact 2f front	Block	Block	Bloque
11	G-04411-46	5		Bloc contacts 4f front	Block	Block	Bloque
12	H-04411-47	2		Temporisateur travail 30s	Zeitschalter	Time-delay	Temporizador
13	E-04411-44	5		Bloc contacts f + o front	Block	Block	Bloque
14	G-14406-11	1		Transfo 500va 3x24	Transformator	Transformer	Transformador
15	T-48413-10	1		Redresseur 25a pos equip	Gleichrichter	Rectifier	Rectificador corrien
16	J-27411-71	1		Contacteur 4x25a b48v	Kontaktgeber	Switch	Contacteur
16A	E-33411-45	1		Bobine 48v (25-32a)	Spule	Coil	Bobina
17	Q-27411-77	1		Relais-auxiliaire 4f b48v	Hilfsrelais	Auxiliary relay	Rele auxiliar
17A	C-33411-43	1		Bobine 48v 50/60hz	Spule	Coil	Bobina
18	Z-13412-90	1		Disjoncteur tetra 38a	Schutzschalter	Autom.circuitbreaker	Interruptor
19	V-13412-87	3		Disjoncteur tetra 15a	Schutzschalter	Autom.circuitbreaker	Interruptor
20	X-13412-89	2		Disjoncteur bipol 10a	Schutzschalter	Autom.circuitbreaker	Interruptor
21	A-13412-68	1		Disjoncteur 10-16a tri	Schutzschalter	Autom.circuitbreaker	Interruptor

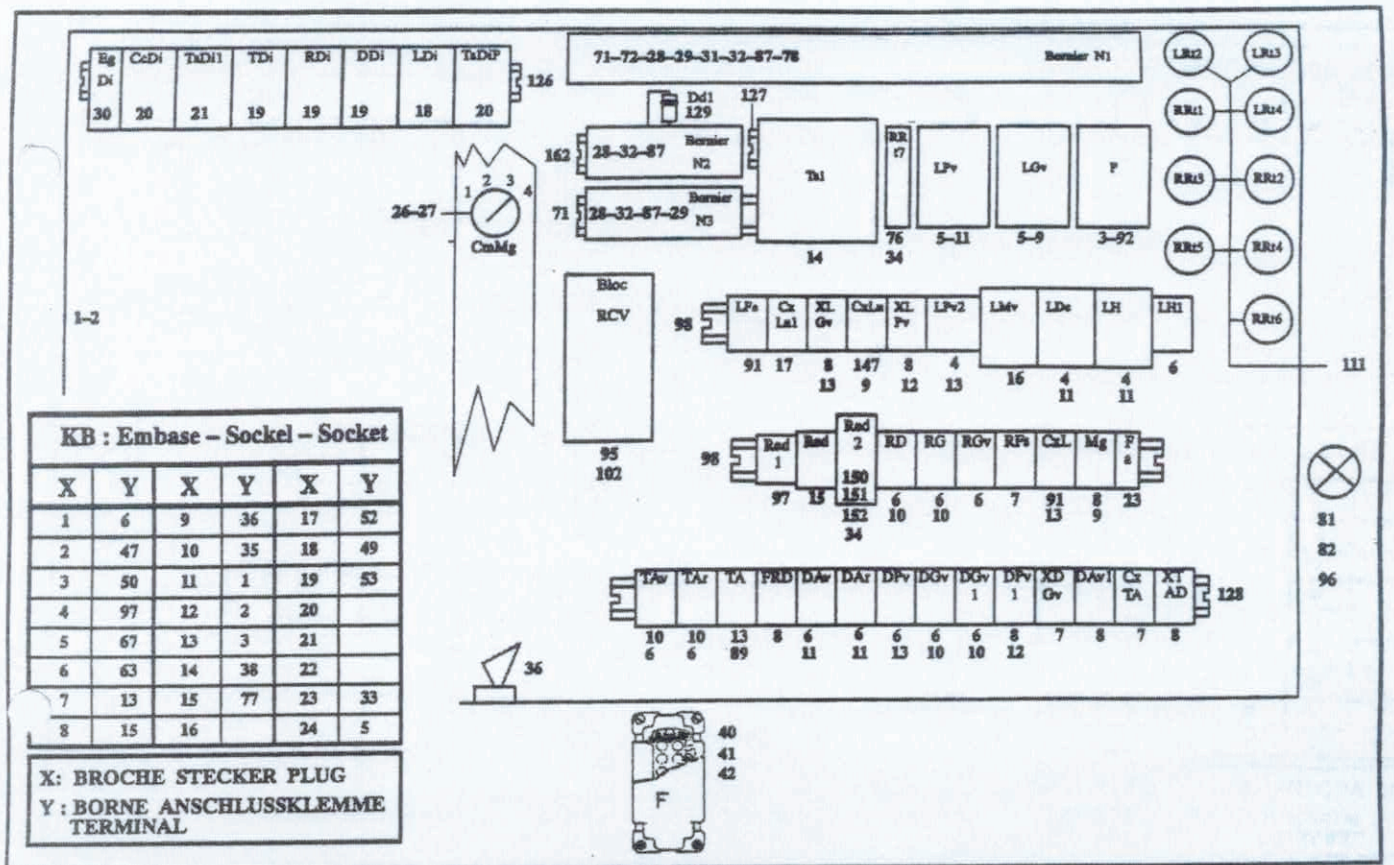

REP	REFERENCE	QTE	S	DESIGNATION	BEZEICHNUNG	DESCRIPTION	DESIGNACION
023	Q-11408-14	1		Borne relais 48v 8a	Anschlussklemme	Terminal	Borna
026	Z-46413-99	1		Commutateur 4 positions	Platte	Plate	Placa
027	R-07515-17	1		Plaque-repere 4 positions	Platte	Plate	Placa
028	Q-08408-25	112		Borne vis 4mm2 pas 6	Anschlussklemme	Terminal	Borna
029	L-08408-90	7		Borne vis 4mm protect p6	Anschlussklemme	Terminal	Borna
030	T-02412-87	1		Disjoncteur unipol 10a	Schutzschalter	Autom.circuitbreaker	Interruptor
031	M-08408-91	2		Borne vis 6mm protect p8	Anschlussklemme	Terminal	Borna
032	U-08408-29	4		Flasque borne 5000	Flansch	Flange	Cara
033	T-00424-75	2		Support resistance	Tragstueck	Support	Soporte
034	X-01417-01	1		Avertisseur 48v a embase	Hupe	Horn	Claxon
037	R-08408-26	3		Borne vis 6mm2 pas 8	Anschlussklemme	Terminal	Borna
039	V-03414-08	1		Tube isolant 8x12 165	Rohr	Pipe	Tubo
040	R-17407-70	1		Prise feme 24c pression	Anschluss	Connection	Toma
041	M-17407-66	1		Embase 24 contacts	Sockel	Socket	Asiento
042	V-17407-28	2		Vis de repere	Schraube	Screw	Tornillo
048	Q-18475-35	1		Plaque code serie	Platte	Plate	Placa
049	X-73475-09	1		Adhesif eclair	Aufkleber	Adhesive	Adhesivo
050	N-33410-61	2		Vide-poche armoire elect	Ablage	Cubbyhole	Guantera
051	Z-01354-23	4		Rivet alu d4x10	Niete	Rivet	Remache
055	A-00347-07	5		Rondelle w6	Scheibe	Washer	Arandela
056	X-11330-93	39		Vis sp	Schraube	Screw	Tornillo
057	G-00348-05	19		Rondelle de 4 de	Scheibe	Washer	Arandela
058	H-00325-29	19		Vis cb m4x16 c15.6	Schraube	Screw	Tornillo
059	E-10045-98	12,7		Fil h07v-k 1,5 orange	Draht	Wire	Hilo
060	T-12045-04	131		Fil h07v-k 1,5 rouge	Draht	Wire	Hilo
061	Z-00045-53	62		Fil h07v-k 2,5 noir	Draht	Wire	Hilo
062	U-12045-05	11,2		Fil h07v-k 2,5 rouge	Draht	Wire	Hilo
063	C-10045-27	1,9		Fil h07v-k 2,5 vert/jaune	Draht	Wire	Hilo
064	T-28414-14	91		Passe-fil de 18	Drahtdurchfuehrung	Guide	Pasacable
071	T-02986-26	2		Profil din 35 sp 1600	Profilstueck	Profile	Perfil
072	G-10410-09	3		Support bornier	Tragstueck	Support	Soporte

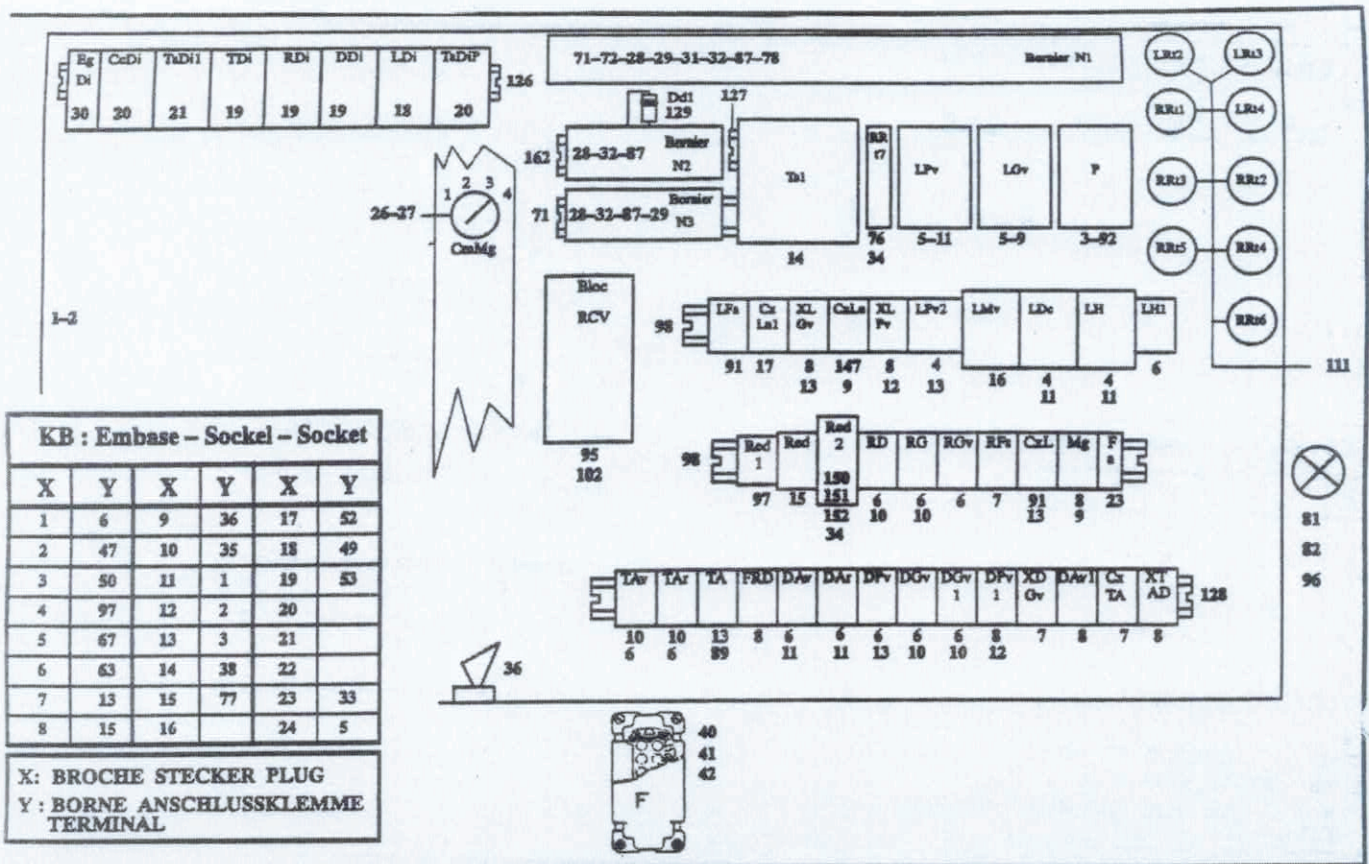

REP	REFERENCE	QTE	S	DESIGNATION	BEZEICHNUNG	DESCRIPTION	DESIGNACION
75	V-00283-32	6		Vis h m6x20 c15.6	Schraube	Screw	Tornillo
76	U-00424-07	1		Resistance 28w 1800 ohms	Widerstand	Resistance	Resistencia
77	W-00283-33	9		Vis h m6x30 classe 56	Schraube	Screw	Tornillo
78	P-03406-66	1		Limiteur surtension 480v	Kaefiglaeufermotor	Squirrel cage motor	Motor jaula ardilla
79	T-00326-31	1		Vis h m6x80 c15-6	Schraube	Screw	Tornillo
80	C-00341-11	36		Ecrou h m6 cl 56	Mutter	Nut	Tuerca
81	R-02405-26	1		Lampe 48v 2,6w	Gluehbirne	Bulb	Bombilla
82	C-46413-33	1		Element signalisation	Element	Element	Elemento
83	U-00350-01	23		Rondelle m 6 n	Scheibe	Washer	Arandela
84	S-13045-53	11,4		Fil special 2,5mm	Draht	Wire	Hilo
85	L-00348-09	41		Rondelle de 6 de	Scheibe	Washer	Arandela
86	X-00045-52	21,7		Fil h07v-k 4 noir	Draht	Wire	Hilo
87	W-08408-31	7		Butee d'arret borne	Anschlag	Stop	Tope
88	X-00341-07	18		Ecrou h m4 cl 56	Mutter	Nut	Tuerca
89	T-28411-61	1		Contacteur 2f+2ox12a b380	Kontaktgeber	Switch	Contacteur
89A	F-33411-46	1		Bobine 380v 50/60hz	Spule	Coil	Bobina
91	U-27411-81	2		Contacteur 4x12a b48v	Kontaktgeber	Switch	Contacteur
91A	C-33411-43	2		Bobine 48v 50/60hz	Spule	Coil	Bobina
92	G-11411-97	1		Bloc contact 3f+10 front	Block	Block	Bloque
95	W-61406-29	1		Bloc rcv gmr 3	Block	Block	Bloque
96	M-46413-42	1		Tete voyant lumin rouge	Kopf	Head	Cabeza
97	H-15406-39	1		Redresseur frein 220v	Gleichrichter	Rectifier	Rectificador corrien
98	S-02986-25	2		Profil din 35 sp 1500	Profilstueck	Profile	Perfil
102	Q-11407-68	2		Fiche 10 bornes	Steckerbuchse	Plug-socket	Enchufe-hembra
104	D-15031-22	2,8		Joint cabine	Dichtung	Seal	Junta
105	D-02031-62	6,4		Joint mousse 25x10 adh	Dichtung	Seal	Junta
106	A-58410-11	1		Came	Nocken	Cam	Leva
107	P-00341-68	1		Ecrou h m14 cl 56	Mutter	Nut	Tuerca
108	E-09520-20	1		Poignee a condamnation	Griff	Handle	Empunadura
109	X-09475-52	1		Plaque-instruct	Hinweisschild	Indicating plate	Placa instrucciones
111	P-00424-25	9		Resistance 100w 3,36	Widerstand	Resistance	Resistencia

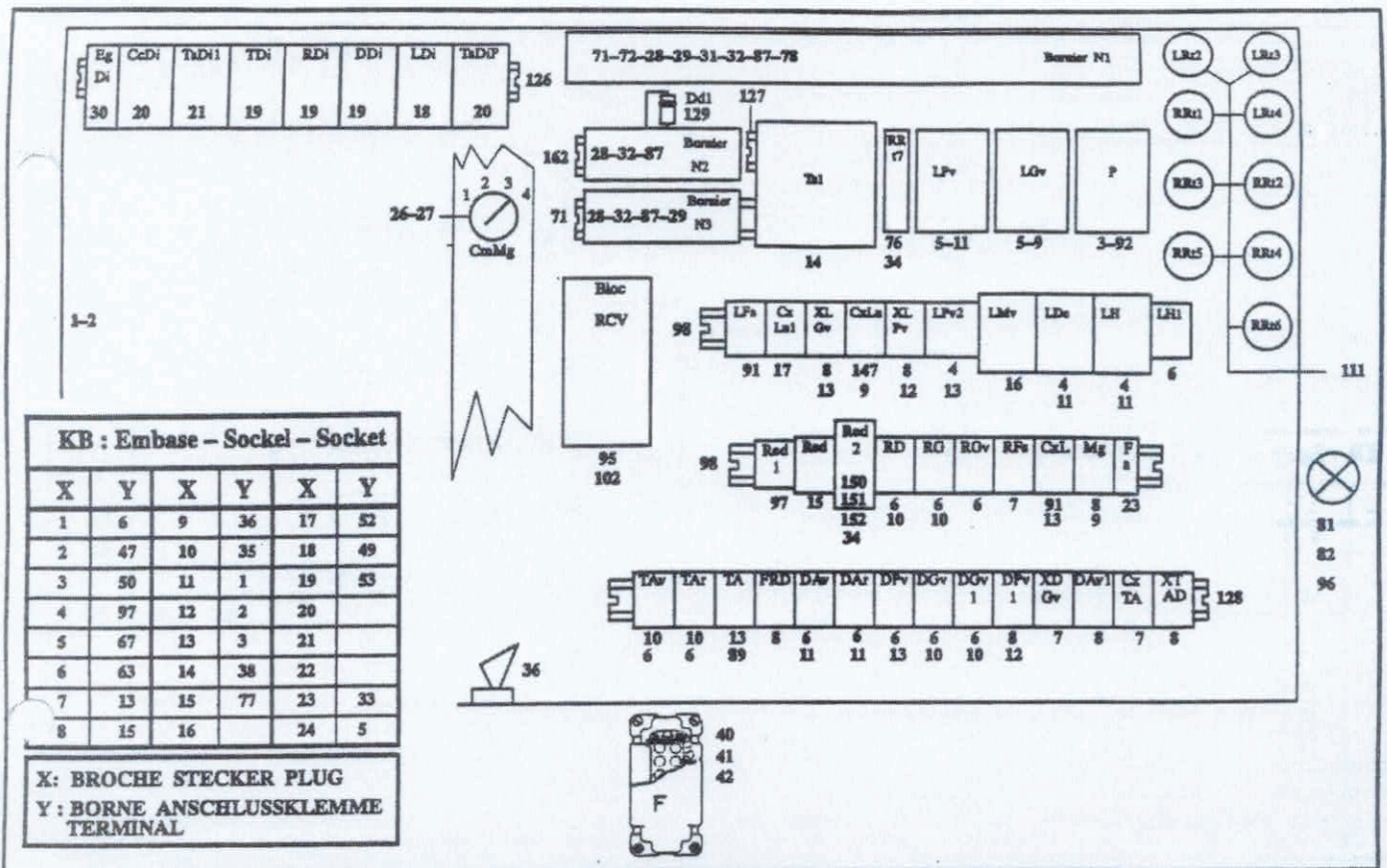

REP	REFERENCE	QTE	S	DESIGNATION	BEZEICHNUNG	DESCRIPTION	DESIGNACION
-----	-----------	-----	---	-------------	-------------	-------------	-------------

113	X-02452-01	18		Rondelle amiante 8,5x40x4	Scheibe	Washer	Arandela
114	E-23277-19	9		Tige filetee m6 1175 lait	Stange	Rod	Esparrago
116	E-11421-15	3		Manchon-caoutch	Gummimuffe	Rubber sleeve	Manguito-goma
117	E-20421-51	3		Support manchon	Tragstueck	Support	Soporte
118	L-01517-18	1		Porte a 2 buses	Tuer	Door	Puerta
119	H-25410-01	1		Grille d'extraction	Gitter	Grill	Reja
121	Q-58410-94	1		Tole ekran	Blech	Plate	Chapa
122	R-58410-95	1		Tole intermediaire	Blech	Plate	Chapa
122	N-49439-31	1		Porte grillagee	Tuer	Door	Puerta
1	T-07986-69	1		Profil din 35 sp 1425	Profilstueck	Profile	Perfil
127	B-02986-56	1		Profil din 35 sp 1450	Profilstueck	Profile	Perfil
128	U-02986-27	2		Profil din 35 sp 1750	Profilstueck	Profile	Perfil
129	G-03406-59	1		Diode 2a 1000v	Diode	Diode	Diodo
130	K-31460-64	1		Joint-caoutch	Gummidichtung	Rubber seal	Junta-goma
131	B-01414-97	1		Passe-fil de 9	Drahtdurchfuehrung	Guide	Pasacable
132	Z-64410-11	1		Tole avant	Blech	Plate	Chapa
133	T-64410-06	2		Arret de porte	Arretierung	Lock	Parada
134	A-00345-46	1		Ecrou hm m14 classe 56	Mutter	Nut	Tuerca
135	V-14285-49	6		Entretoise 10,2 130	Distanzstueck	Spacer	Distanciador
137	M-02520-91	1		Clef manoeuvre	Schluessel	Spanner	Llave
138	V-00350-02	4		Rondelle m 8 n	Scheibe	Washer	Arandela
139	P-00348-12	4		Rondelle dec 8 nfe-27624	Scheibe	Washer	Arandela
140	E-00341-13	4		Ecrou h m8 cl 56	Mutter	Nut	Tuerca
141	G-00326-43	4		Vis h m8x25/25 c15.6	Schraube	Screw	Tornillo
145	V-18345-45	14		Ecrou m6 pour din 35	Mutter	Nut	Tuerca
146	G-11408-75	5		Cavalier de reprise	Buegel	Bracket	Horquilla
147	X-27411-61	1		Contacteur 3x18a to b48v	Kontaktgeber	Switch	Contacteur
147	C-33411-43	1		Bobine 48v 50/60hz	Spule	Coil	Bobina
147	R-27424-66	1		Isolateur 14x17 m4x10	Widerstand	Resistance	Resistencia
150	N-00424-01	1		Resistance 28w 120	Widerstand	Resistance	Resistencia
151	L-03406-86	2		Diode transil 33v 5kw bi	Diode	Diode	Diodo

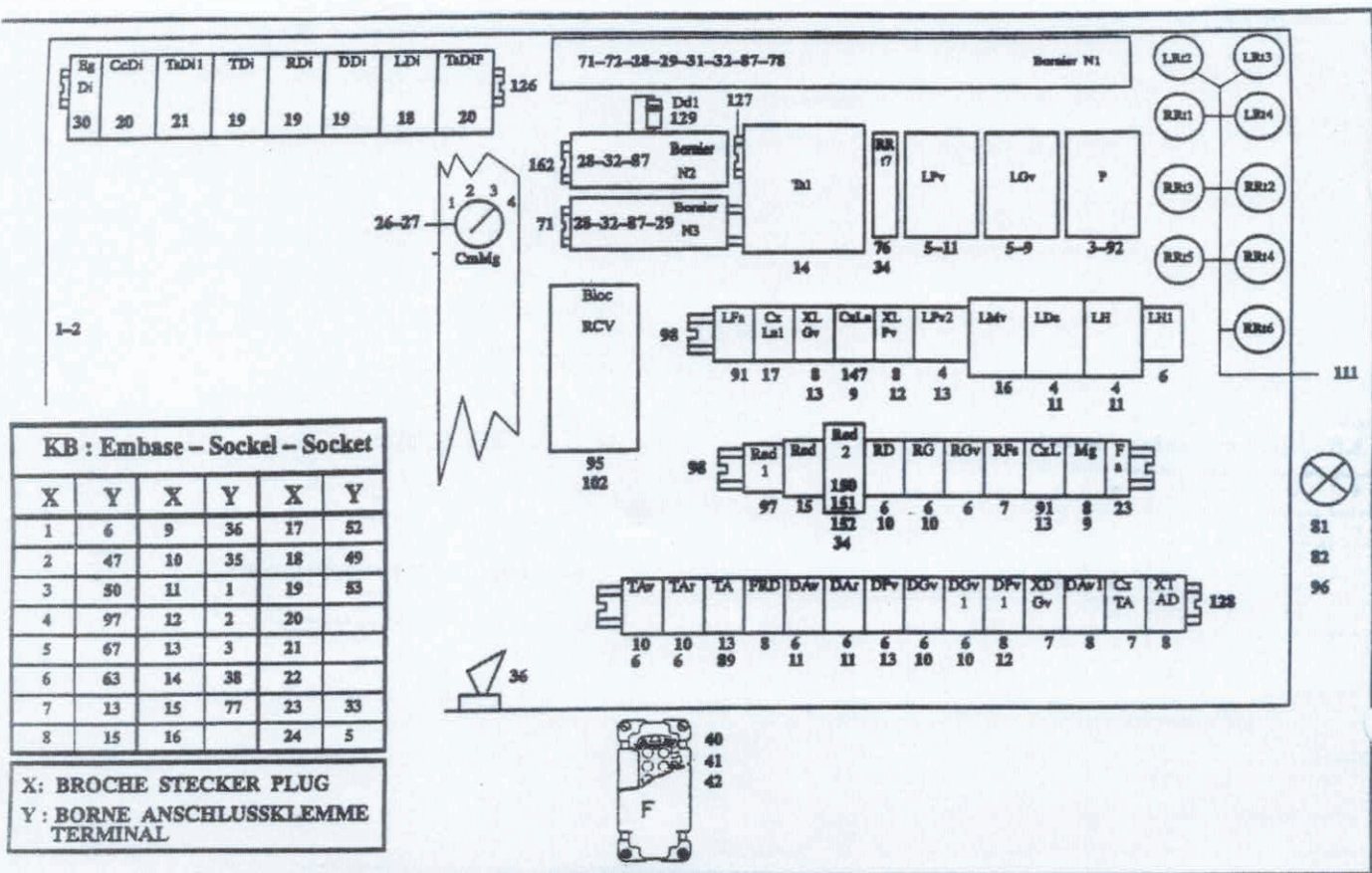

REP	REFERENCE	QTE	S	DESIGNATION	BEZEICHNUNG	DESCRIPTION	DESIGNACION
152	Z-00283-35	5		Vis h m6x16 c15.6	Schraube	Screw	Tornillo
158	G-00345-98	6		Ecrou-secur m10x150 c18	Sicherheitsmutter	Safety nut	Tuerca seguridad
159	G-28414-49	1		Entretoise m4 120	Distanzstueck	Spacer	Distanciador
160	U-01363-16	2		Anneau truarc 6 e	Ring	Ring	Argolla
162	E-02986-59	1		Profil din 35 sp 1150	Profilstueck	Profile	Perfil
164	A-00045-54	3		Fil h07v-k 1,5 noir	Draht	Wire	Hilo
165	H-11407-61	1		Embase f 2x16a + t	Socket	Socket	Asiento
166	K-11407-63	1		Embase f 2x16a 24v	Socket	Socket	Asiento
167	Z-01350-09	10		Rondelle 11 8 n	Scheibe	Washer	Arandela
168	K-00350-15	4		Rondelle m4n	Scheibe	Washer	Arandela