

Schaltplan Potain 330B

48v 50Hz
57v 60Hz

330B

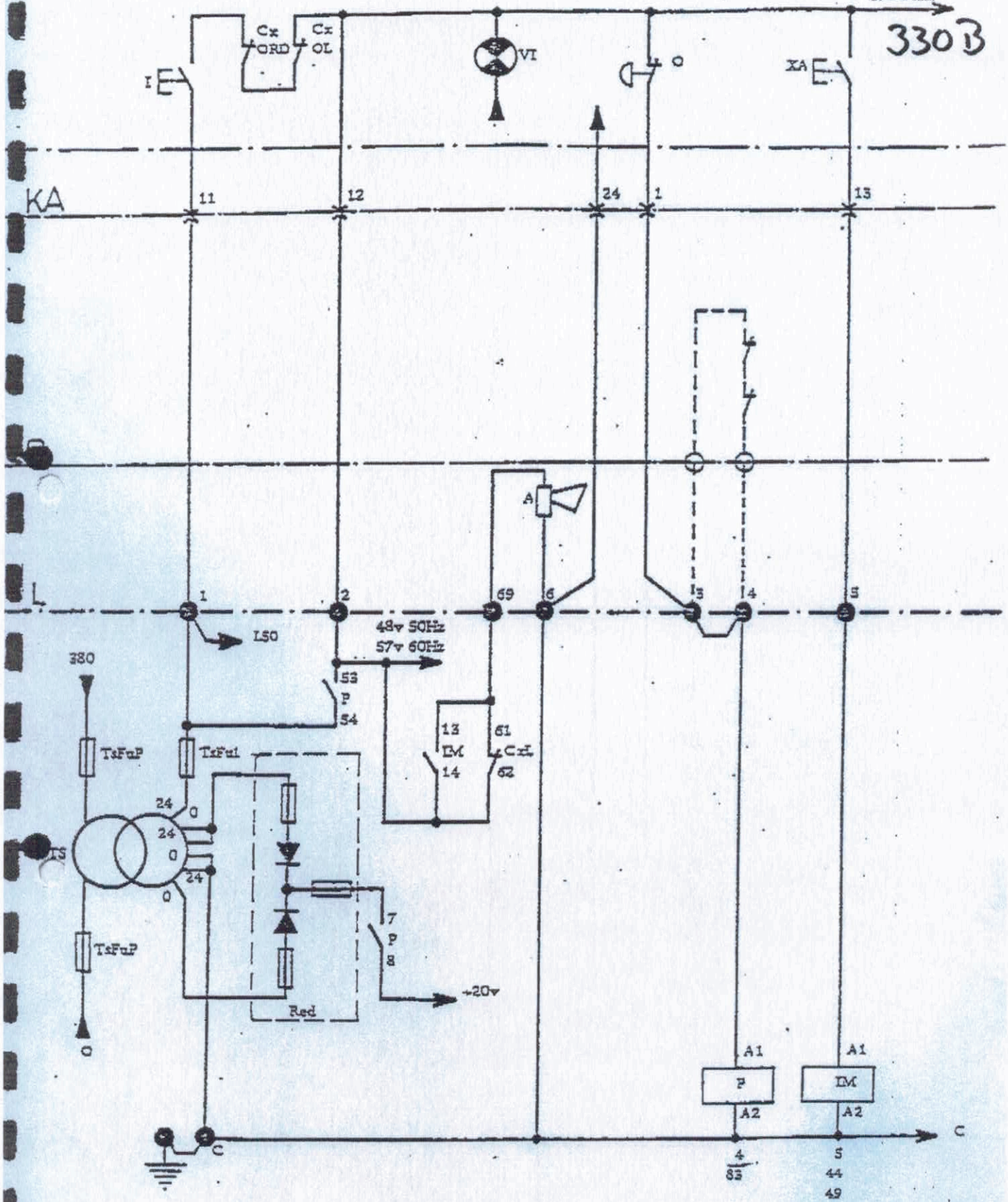

330B

CR 53231 1/11

A 2019 06 00

1-FEB-96 DO 15:26

49 6105 704159

S.02

330B

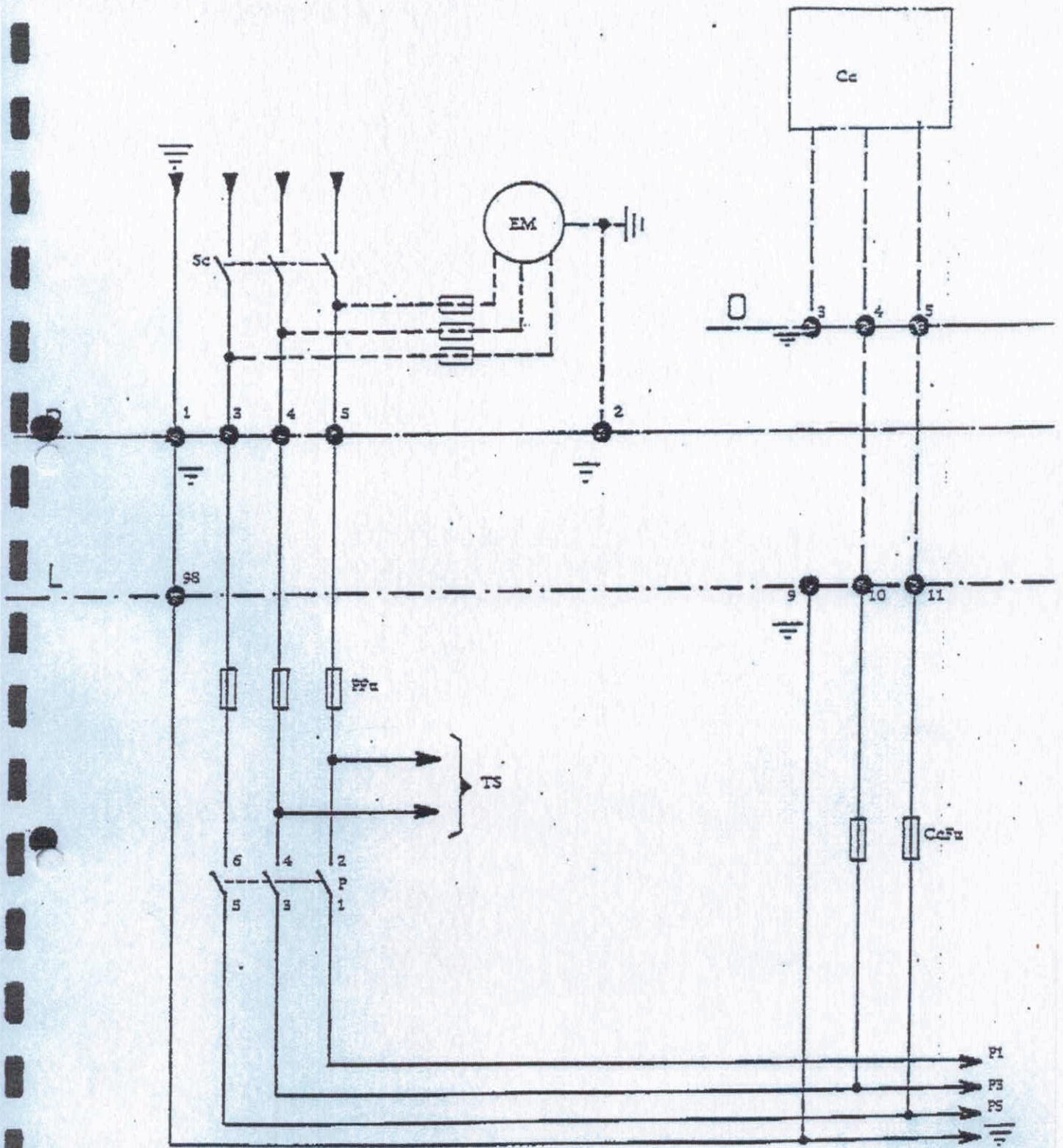

330B

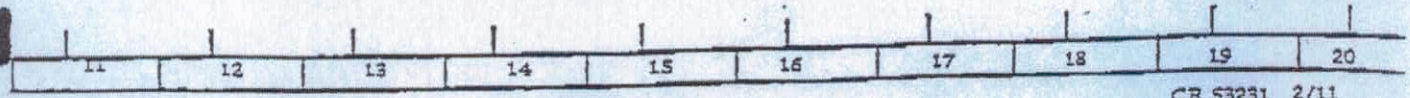

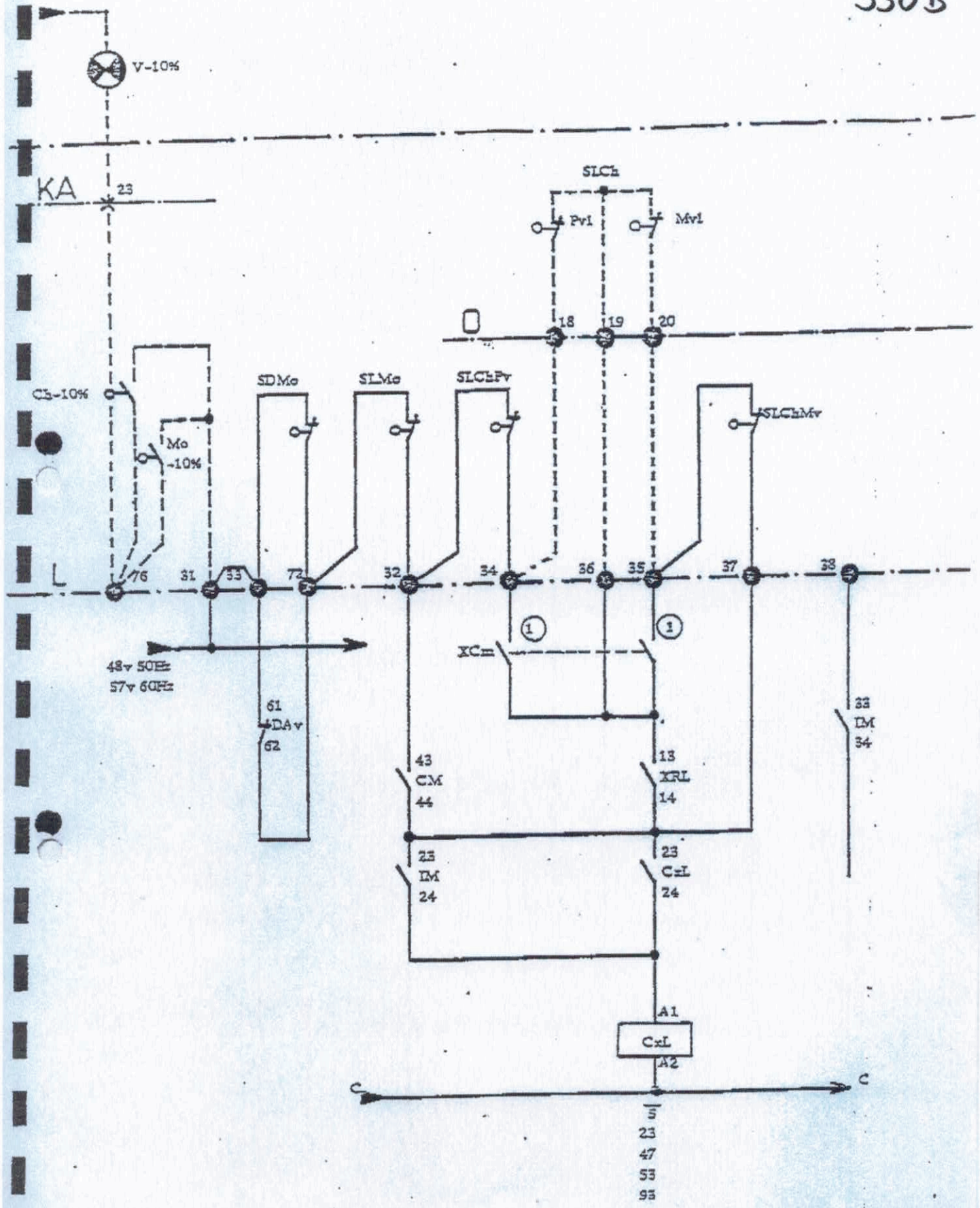

48v 50Hz
57v 60Hz

A1
CxL
A2

41	42	43	44	45	46	47	48	49	50
----	----	----	----	----	----	----	----	----	----

CR 53231 s/11

Schienenfahrwerk
330 B

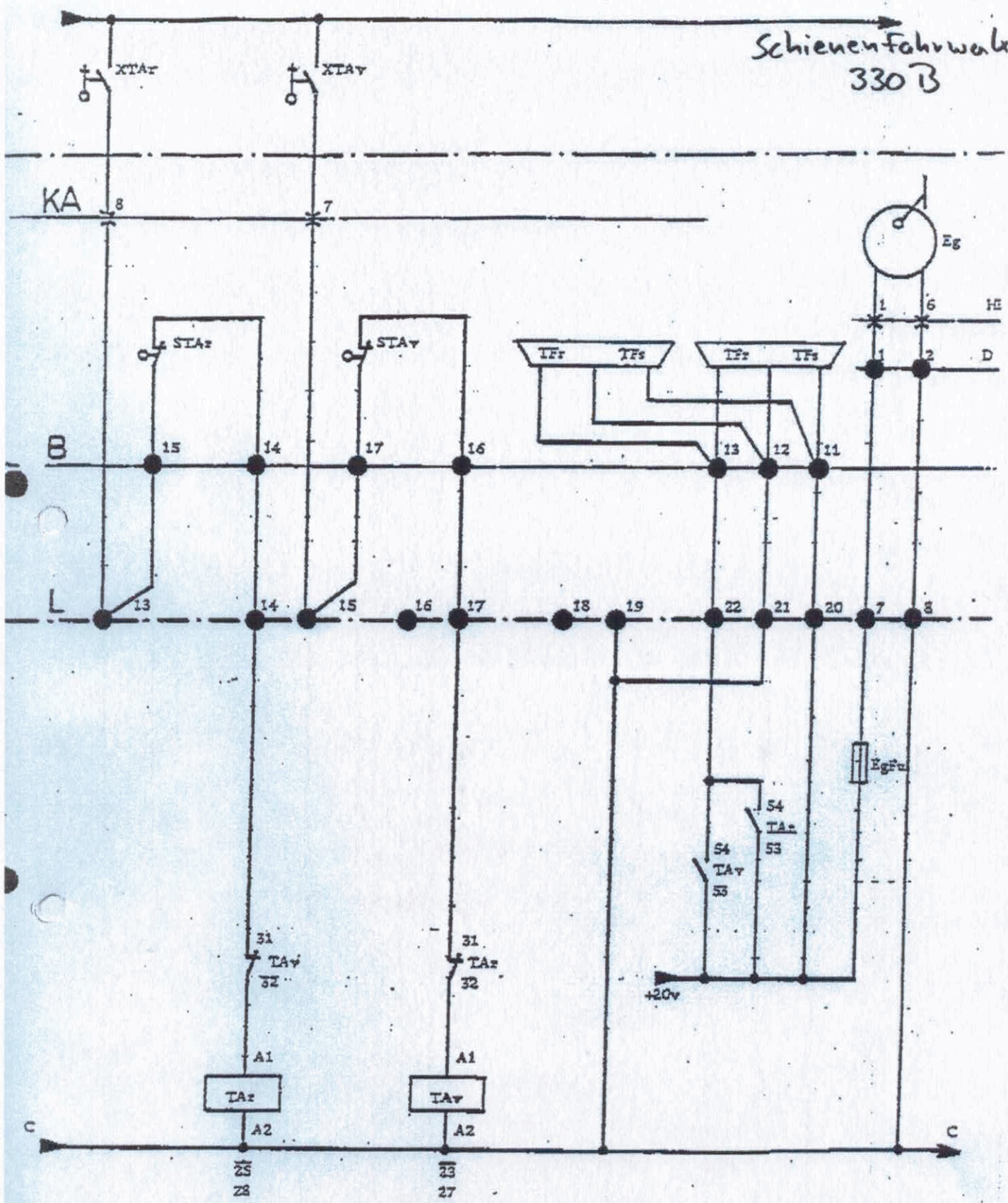

330 B

21	22	23	24	25	25	27	28	29	30
								CR 5.3524 1/1	
A 20 23 06 01									

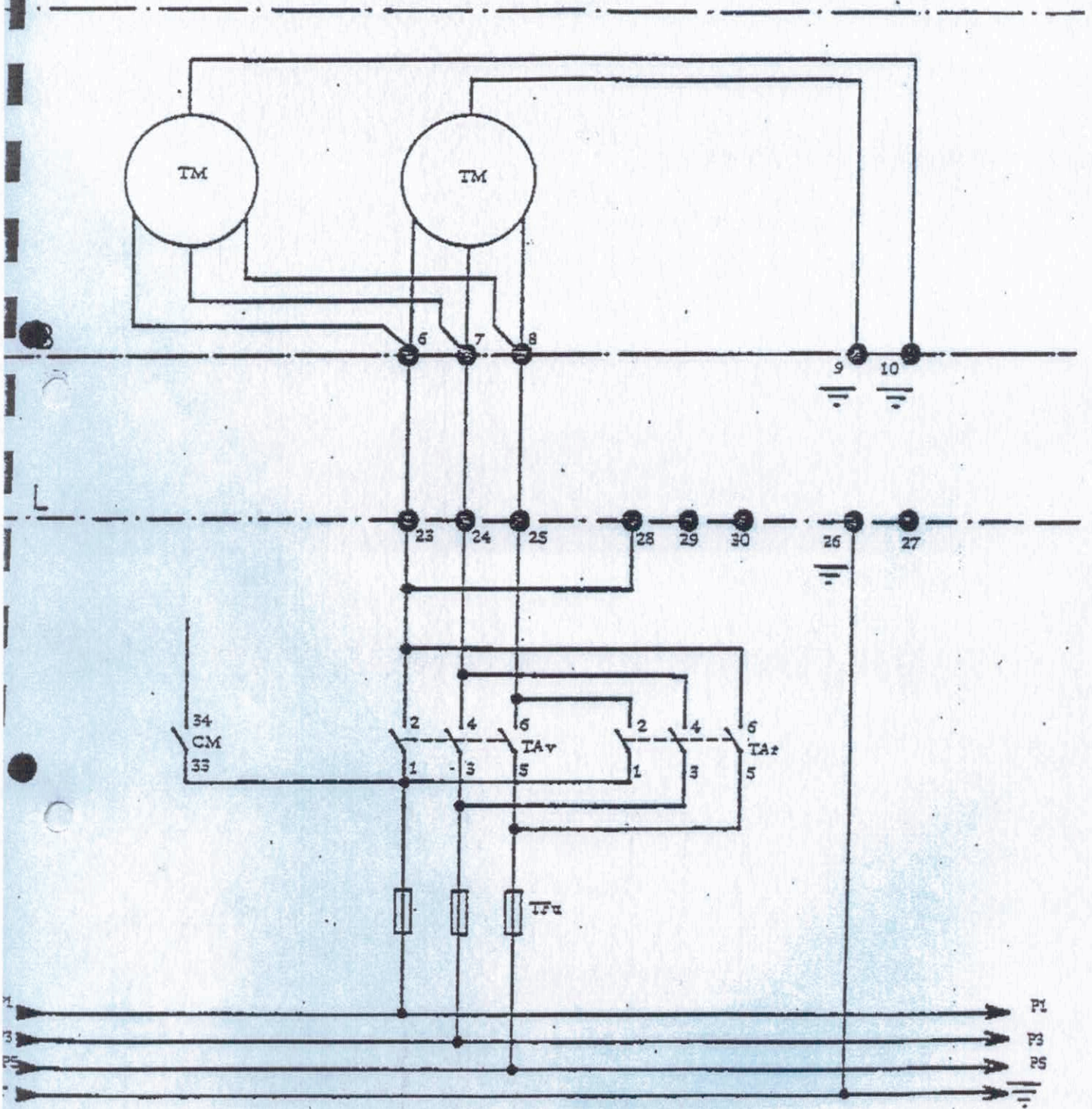

330B

31	32	33	34	35	36	37	38	39	40
----	----	----	----	----	----	----	----	----	----

CR 53231 4/11

Alt ohne Widerstandskarte

57v 60Hz

KA

48v 50Hz
57v 60Hz

C

330B

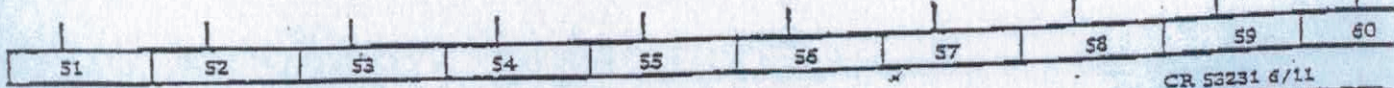

1-FEB-96 DO 15:27

49 6105 704159

CR 53231 6/11

S. 06

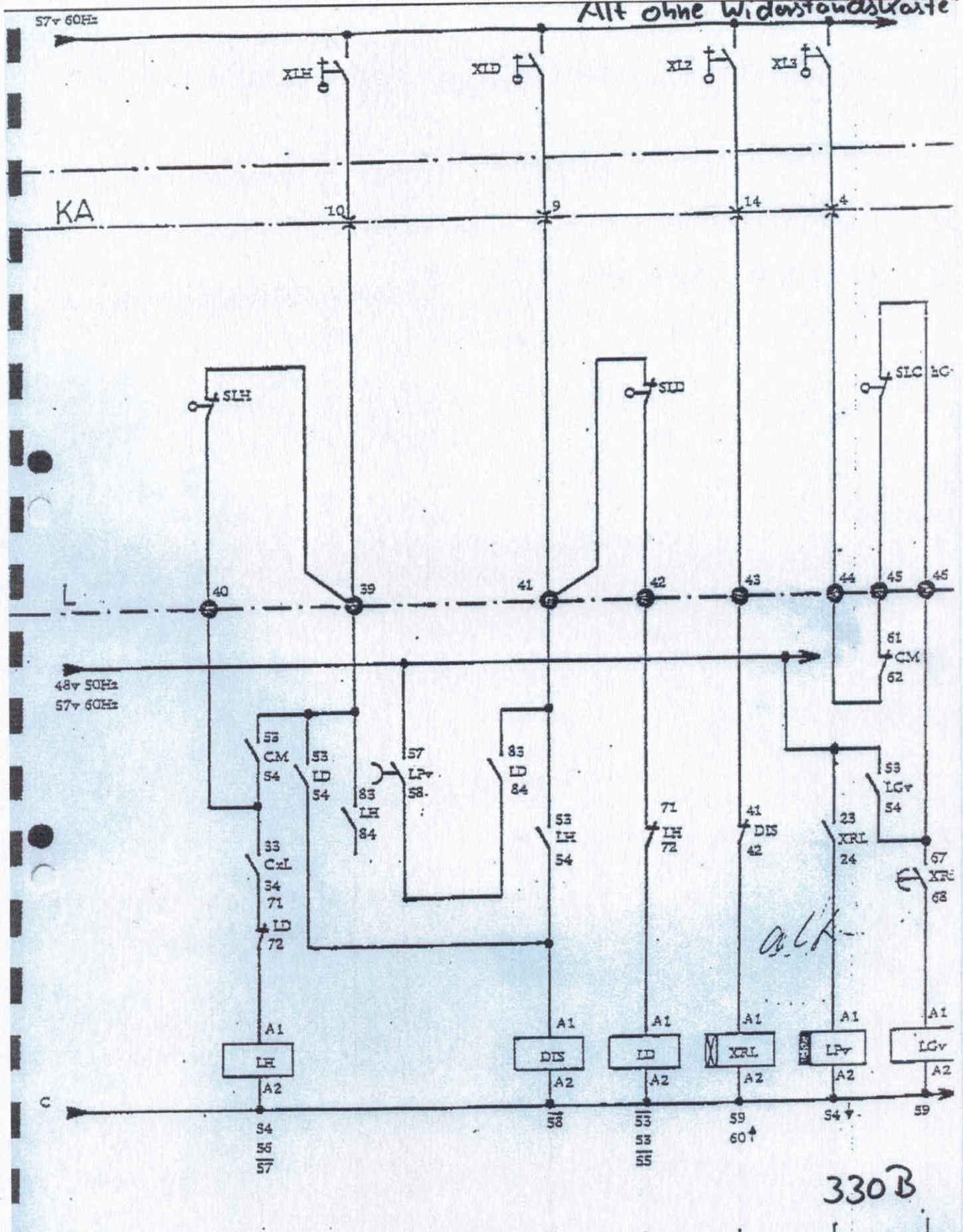

Alt ohne Widerstandskai

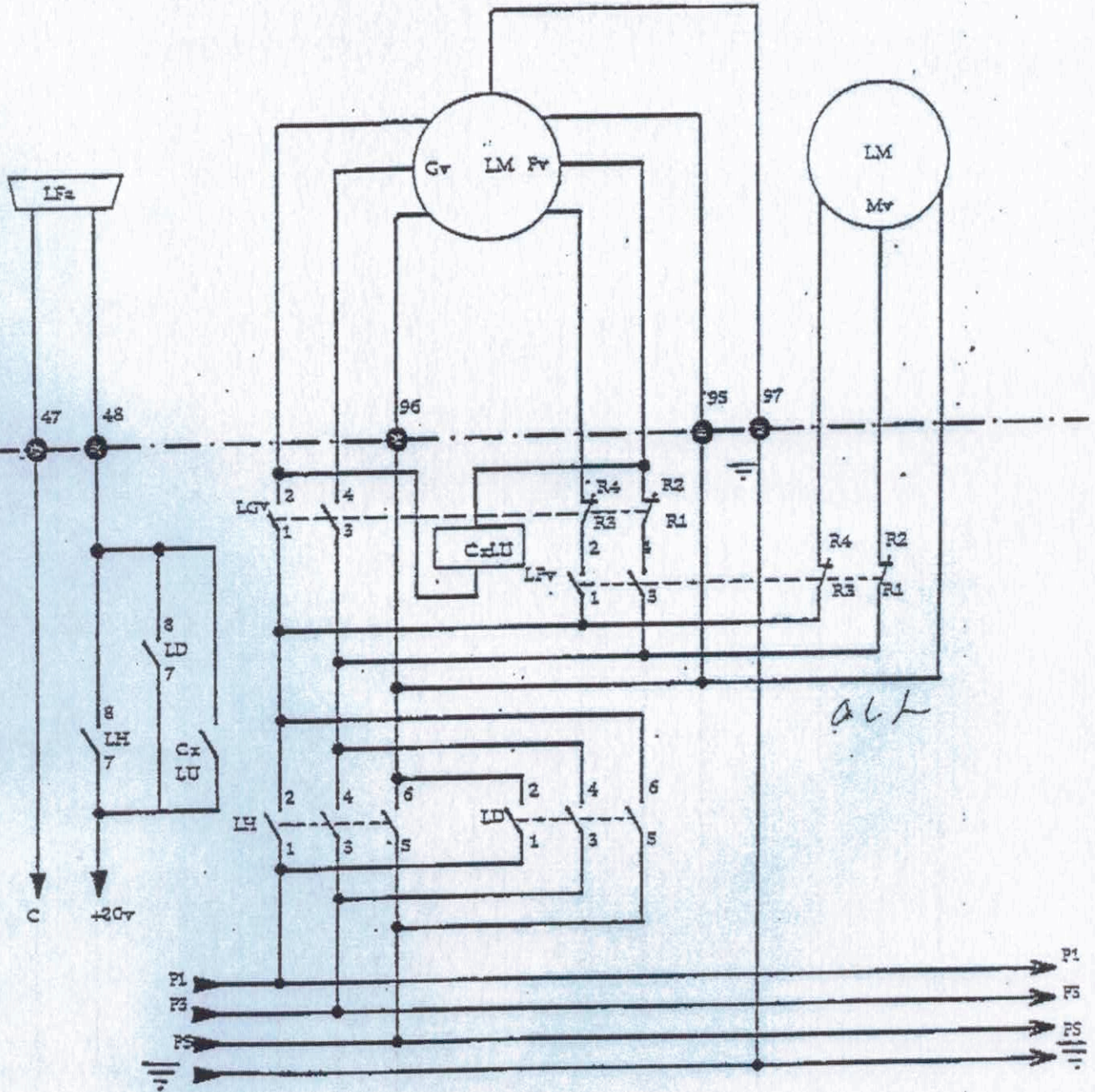

61	62	63	64	65	66	67	68	69	70
----	----	----	----	----	----	----	----	----	----

CR 53375 7/10

A 20 29 06 00

Neu mit Widerstandskasten

48v 50Hz
57v 60Hz

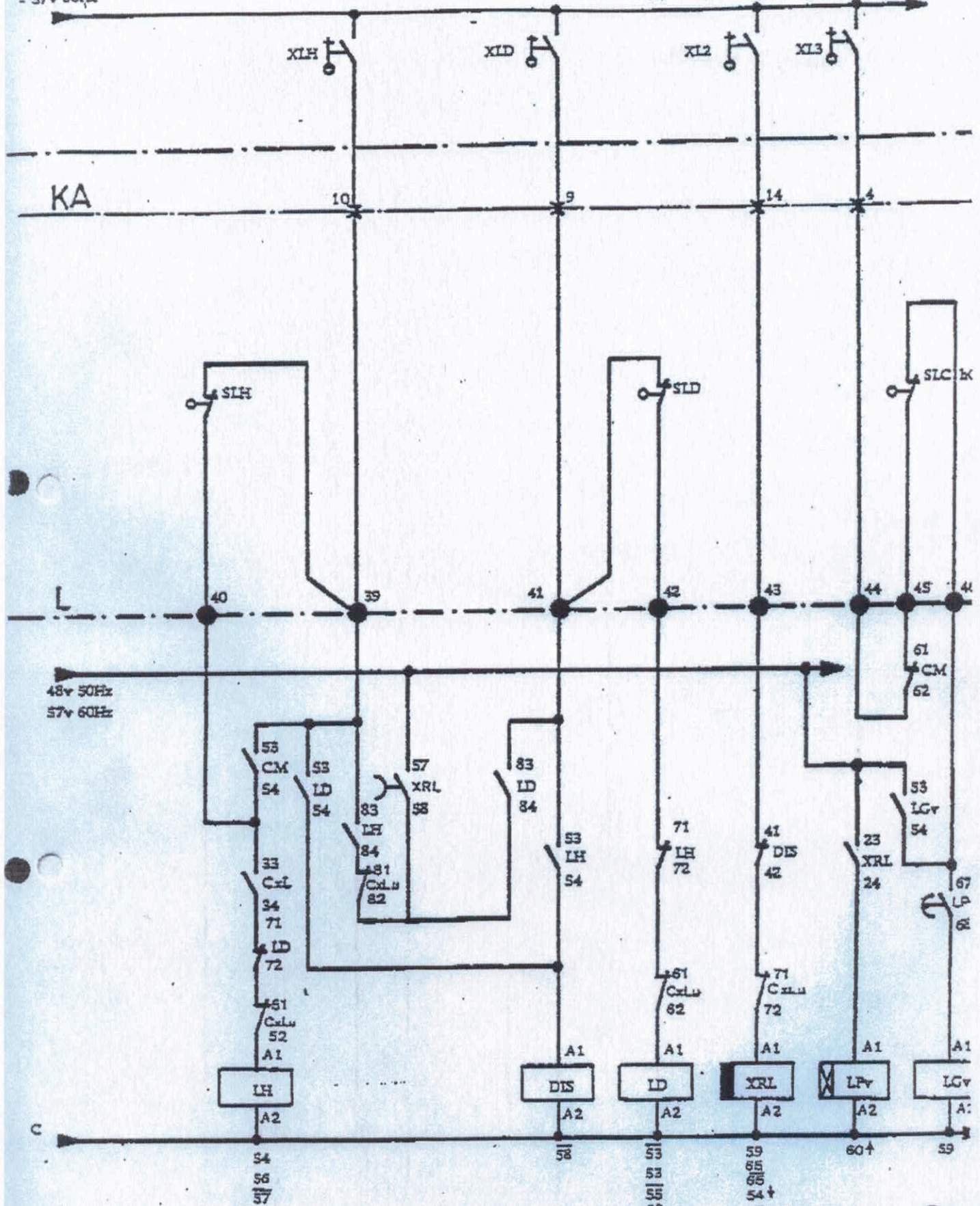

330 B

51	52	53	54	55	56	57	58	59	60
----	----	----	----	----	----	----	----	----	----

CR 53231 6/11

A 20 28 06 02

Neu mit Widerstandskasten

330 B

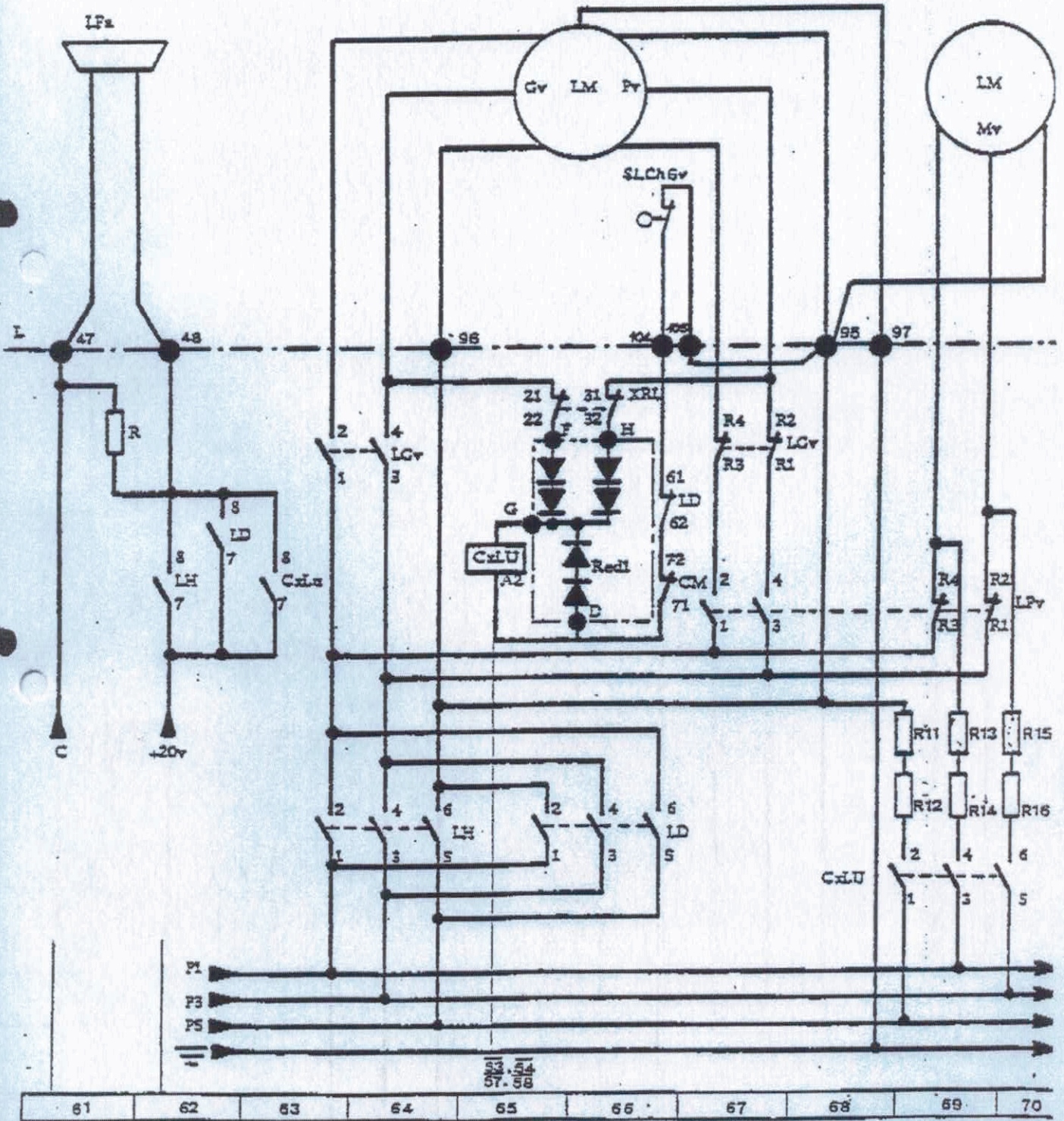

A 20 29 06 03

CR5 3375

57v 60Hz

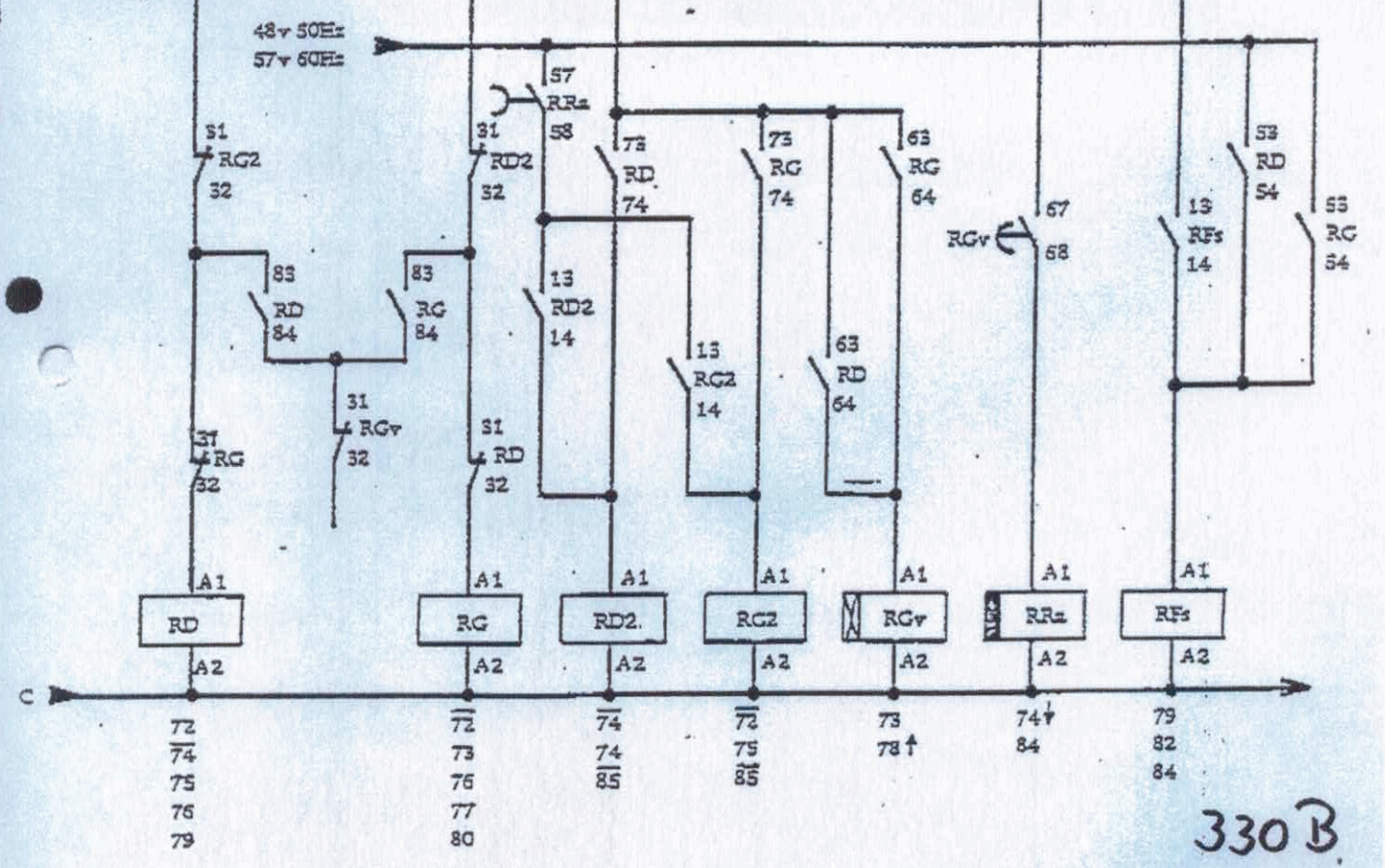
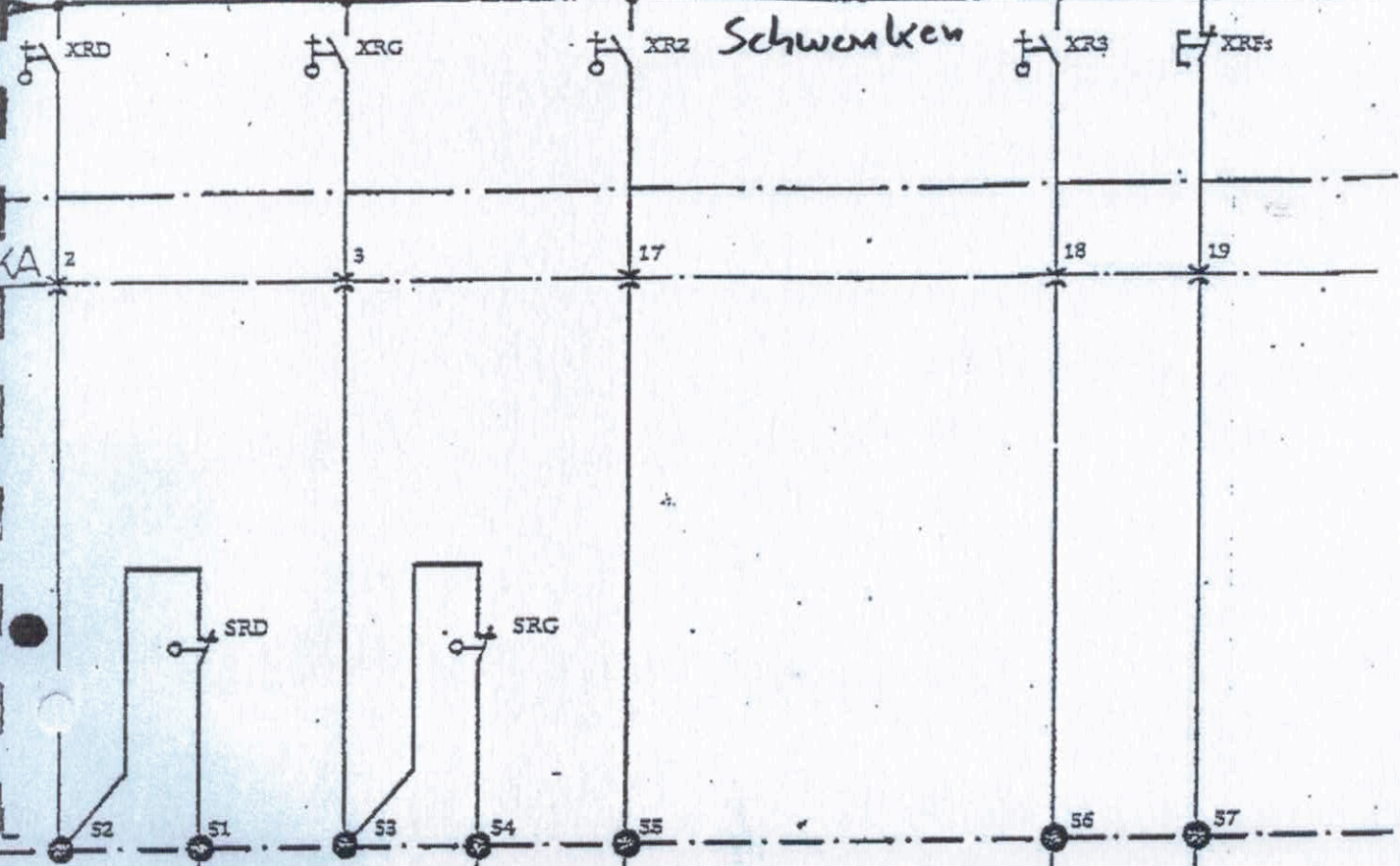

330 B

71	72	73	74	75	76	77	78	79	80
----	----	----	----	----	----	----	----	----	----

CR 53251 8/11

A 20 34 06 00

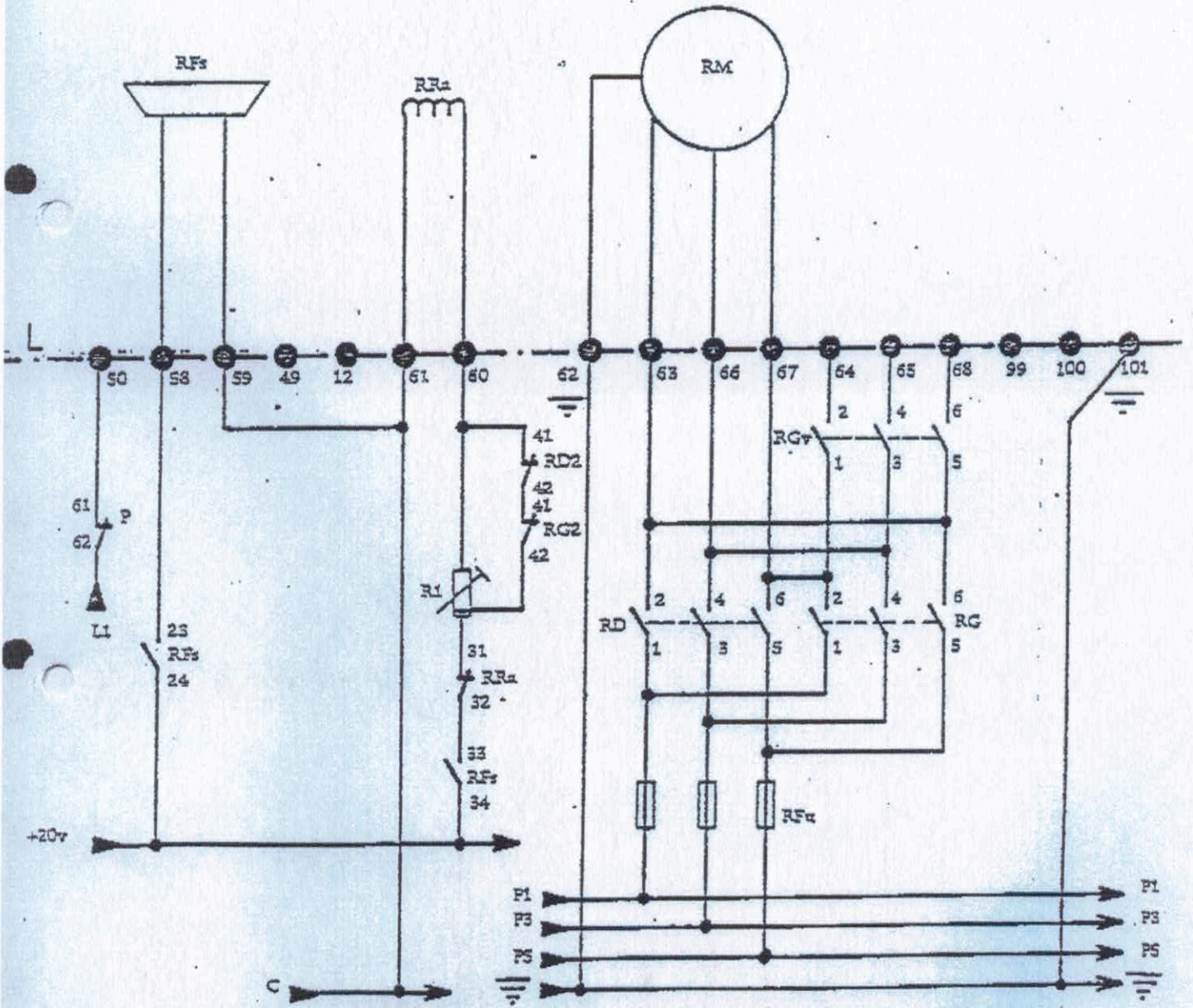

330B

81	82	83	84	85	86	87	88	89	90
----	----	----	----	----	----	----	----	----	----

CR 55231 9/11

Laufkatze 1. Stufe

48v 50Hz
57v 60Hz

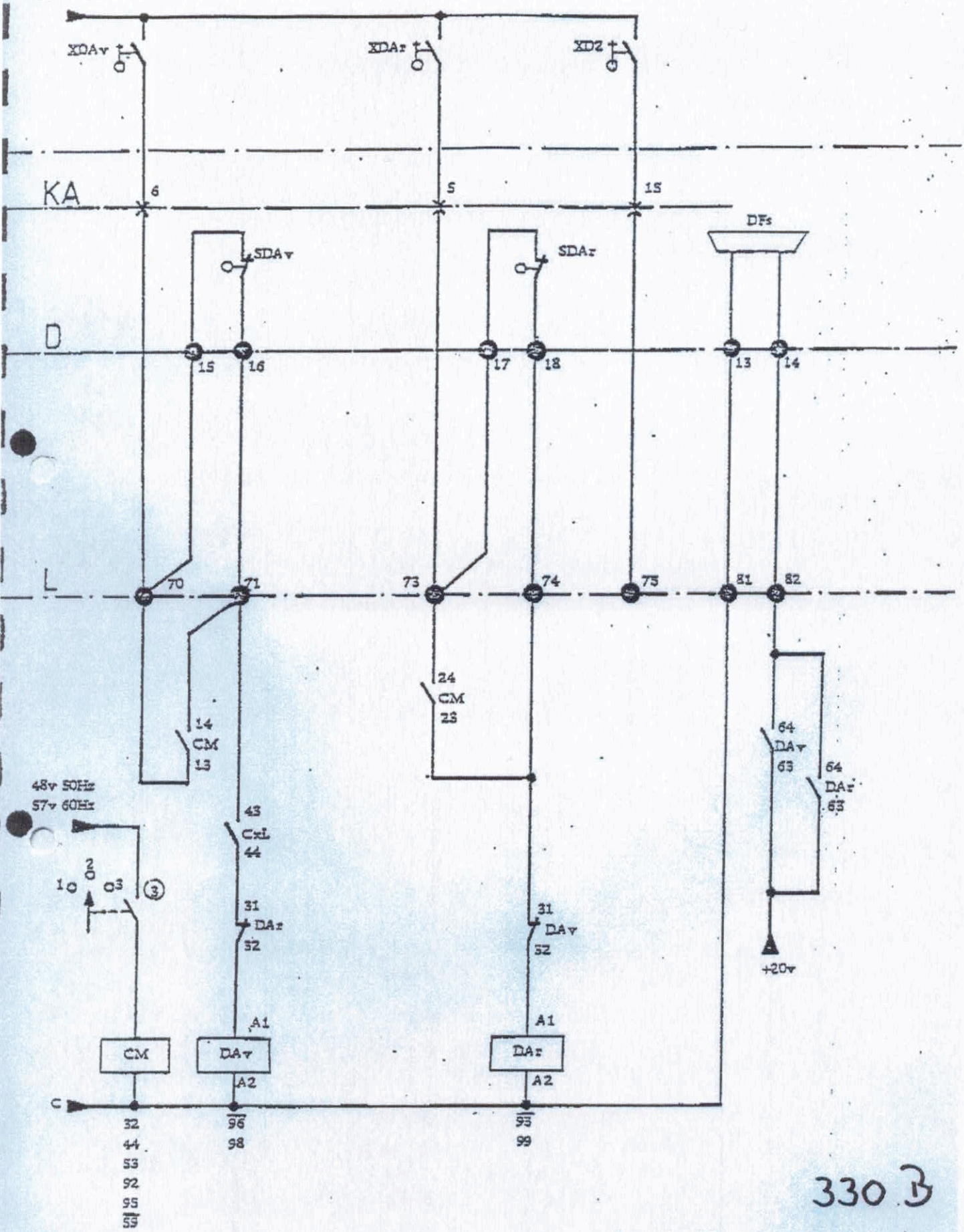

330 B

91	92	93	94	95	96	97	98	99	100
----	----	----	----	----	----	----	----	----	-----

CR 53366 10/11

Laufkatze 1 Stufe

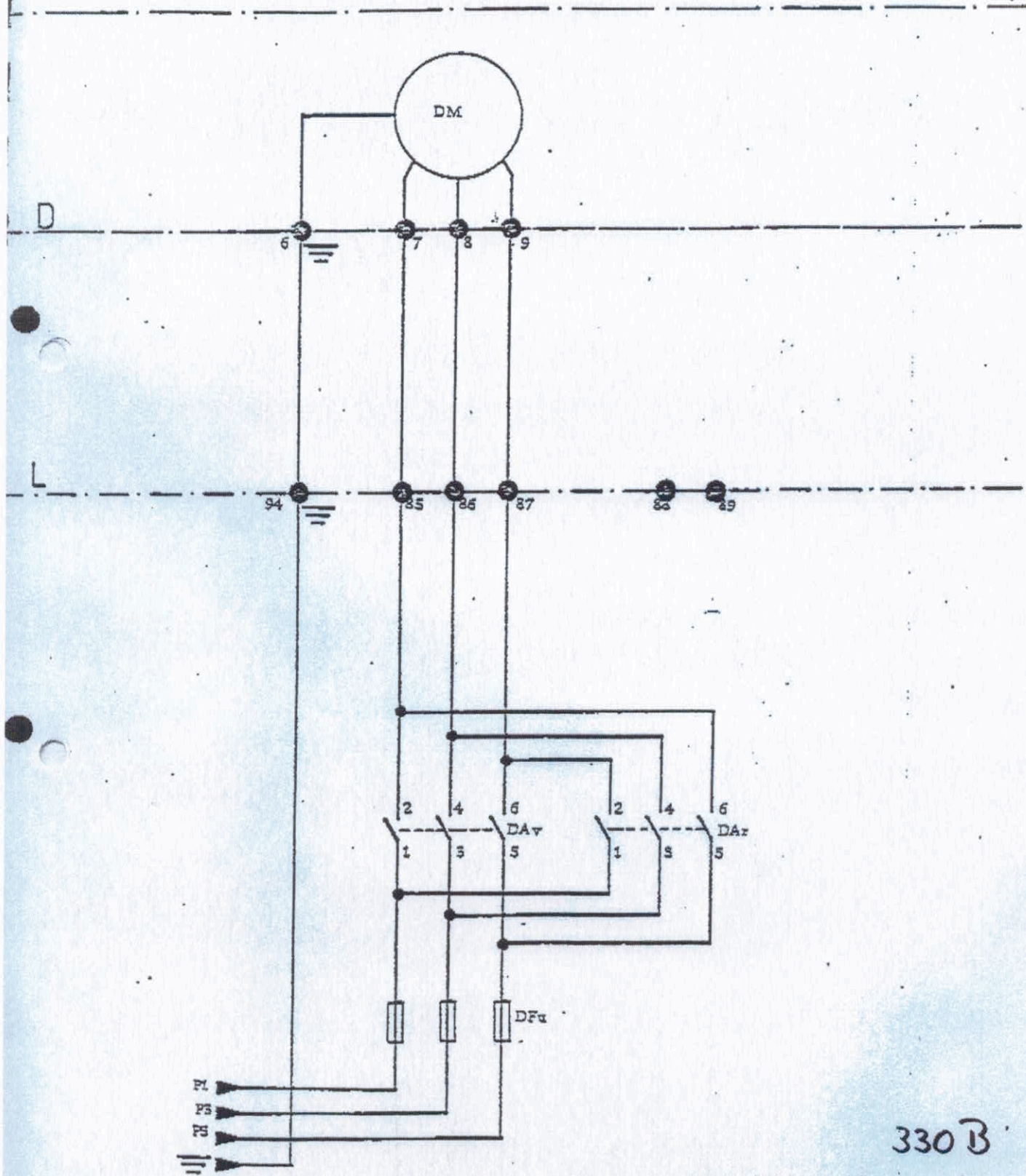

330 B

101	102	103	104	105	106	107	108	109	110
-----	-----	-----	-----	-----	-----	-----	-----	-----	-----

CR 53566 11/11

48v 50Hz
57v 60Hz

Laufkatze 2 Stufen

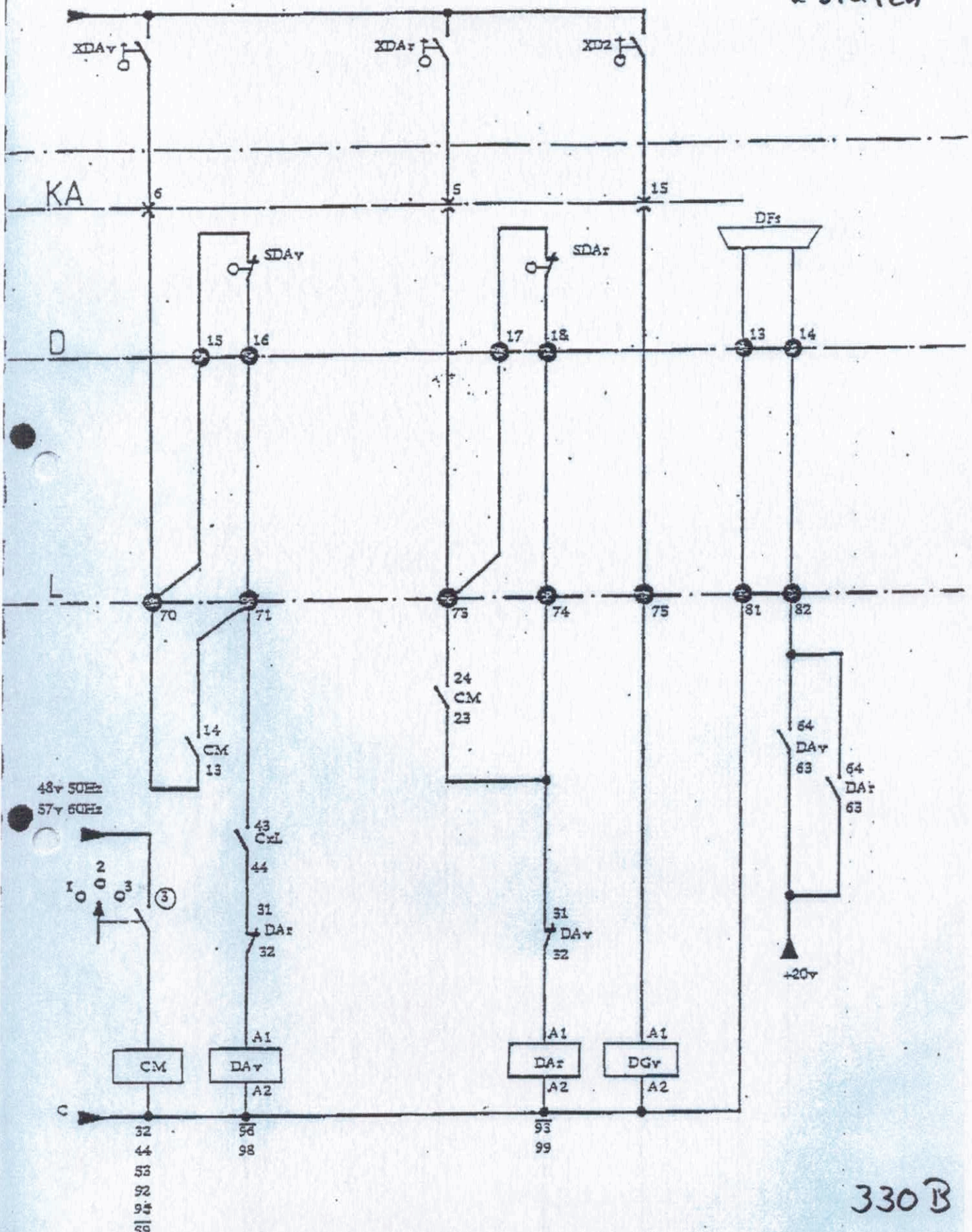

330 B

91	92	93	94	95	96	97	98	99	100
----	----	----	----	----	----	----	----	----	-----

CR 53231 10/11

Laufkatze
2 Stufen

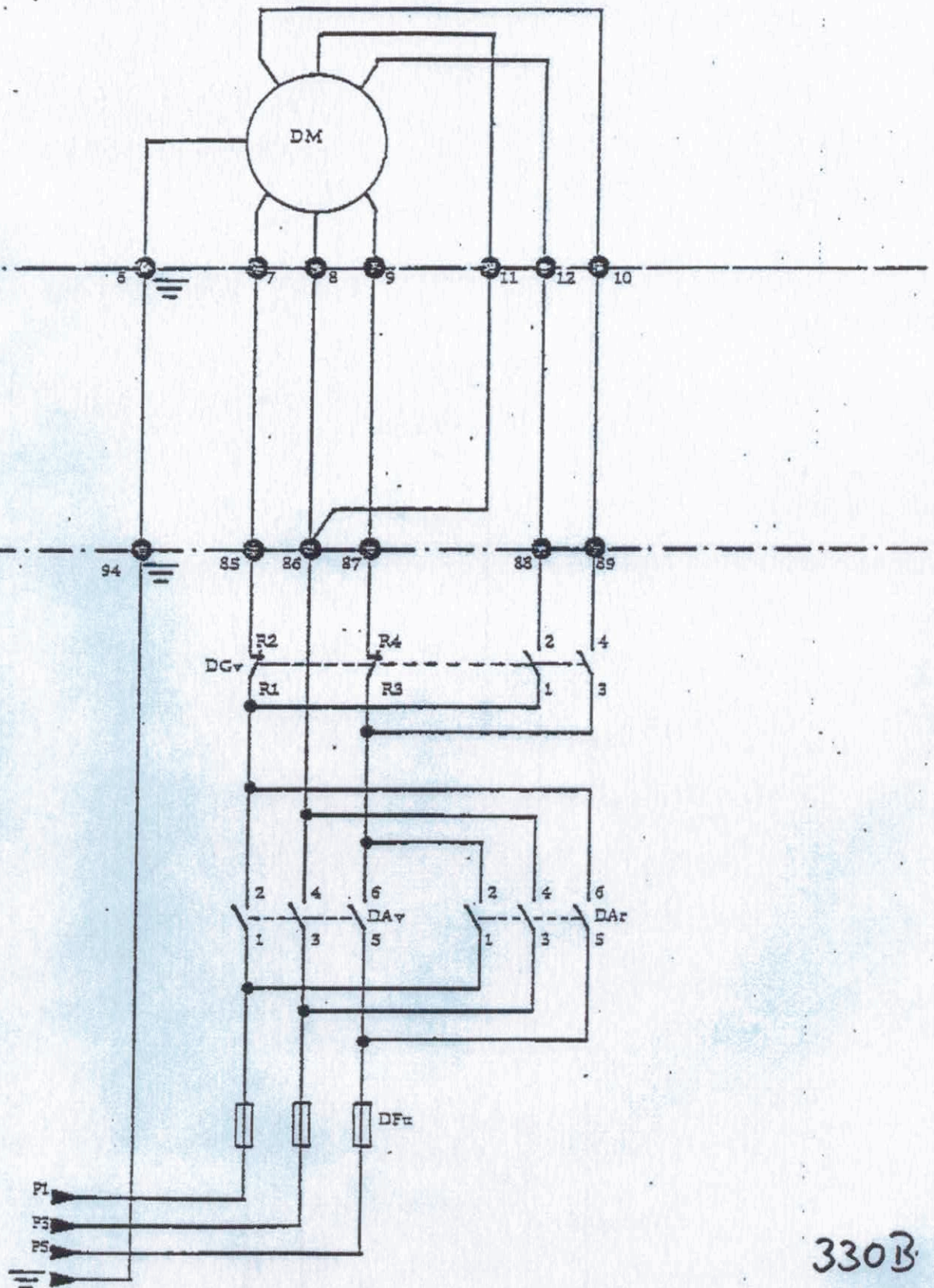

330B

101	102	103	104	105	106	107	108	109	110
-----	-----	-----	-----	-----	-----	-----	-----	-----	-----

CR 53231 11/11