

**Schaltplan**  
**Potain 321B**  
**#62755**  
**1988**

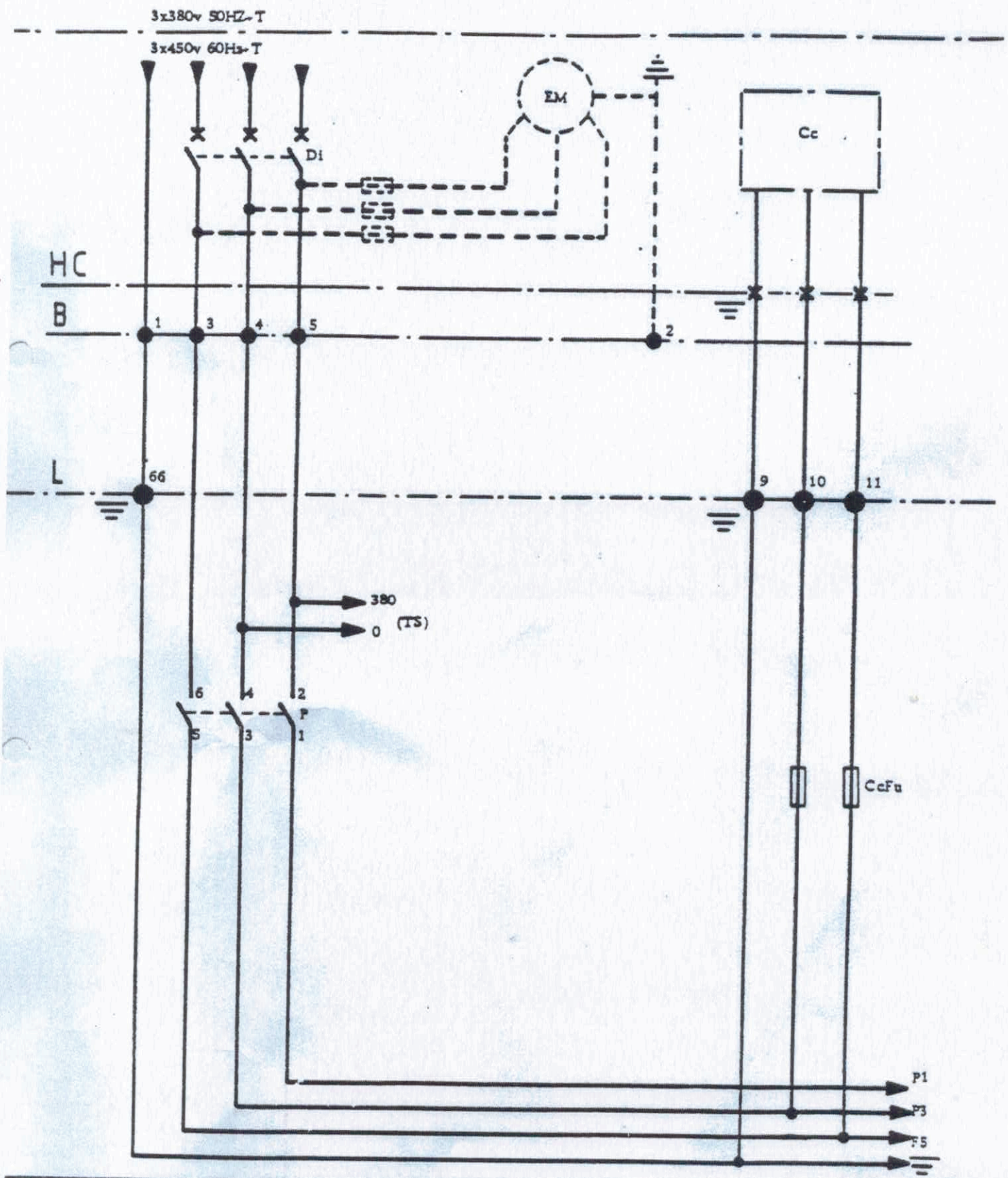





51	52	53	54	55	56	57	58	59	60
----	----	----	----	----	----	----	----	----	----

A 00 105 03 00

48v 60Hz  
57v 60Hz

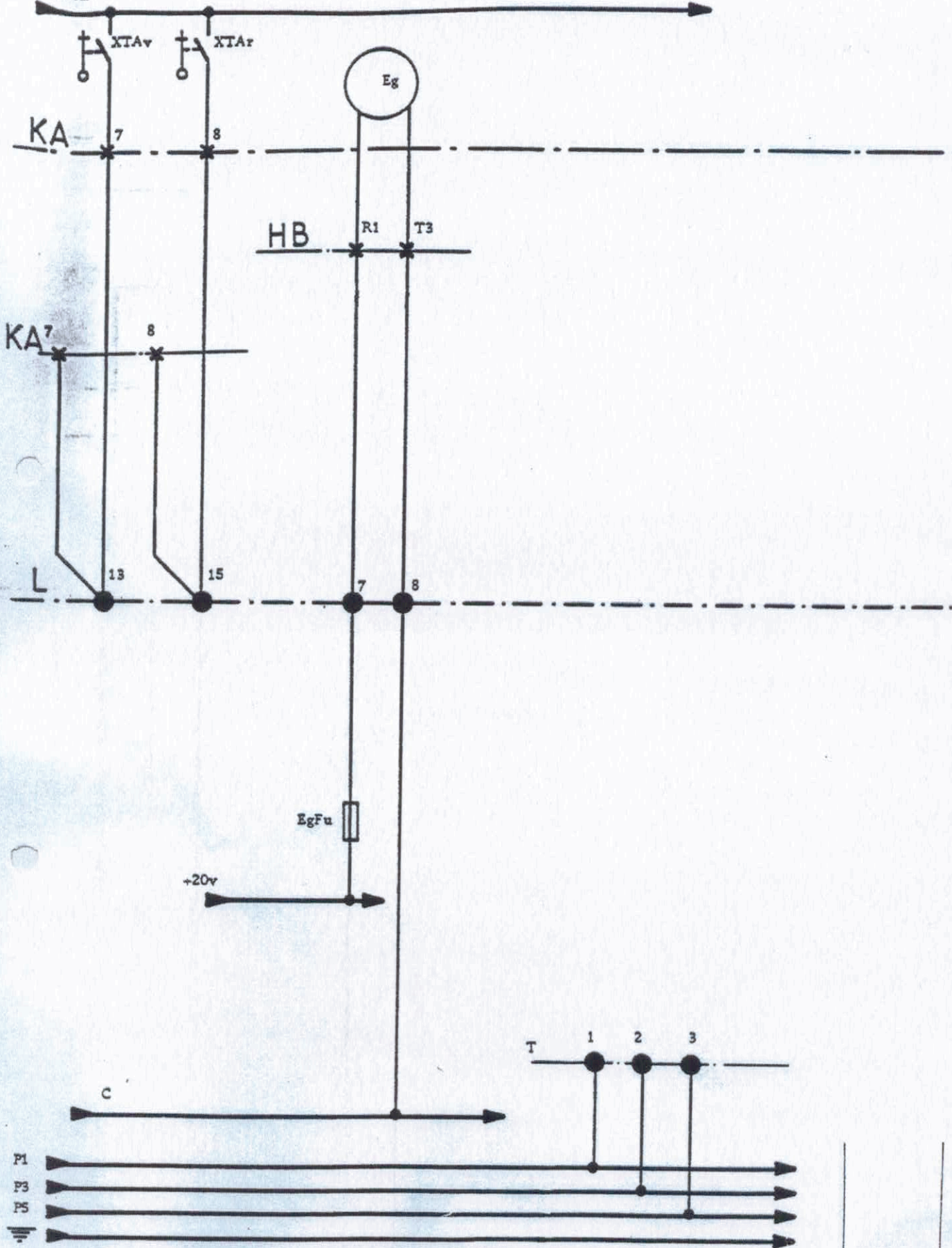

101	102	103	104	105	106	107	108	109	110
-----	-----	-----	-----	-----	-----	-----	-----	-----	-----

A 00 110 17 00



48v 50Hz  
57v 60Hz

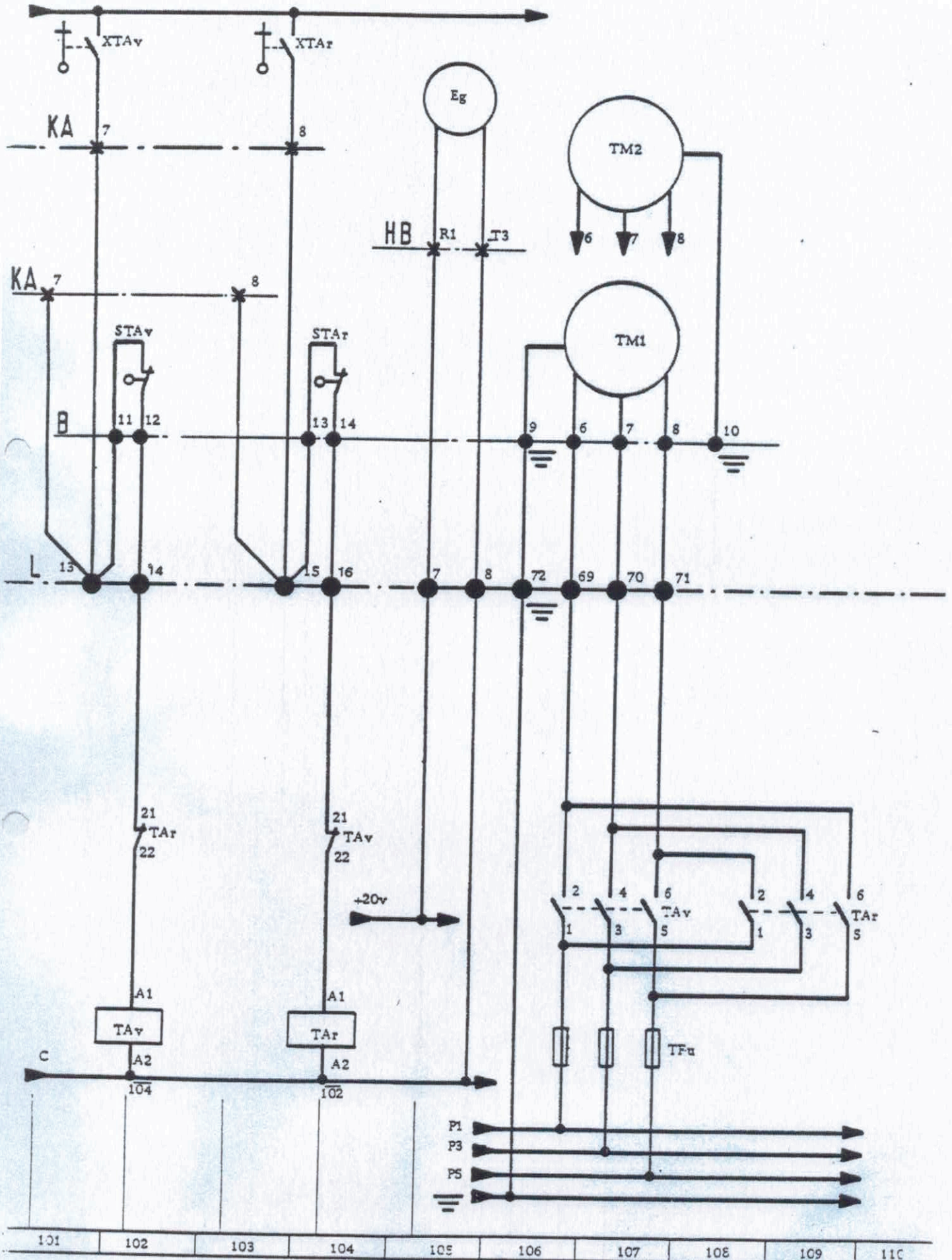

A 00 110 18 00

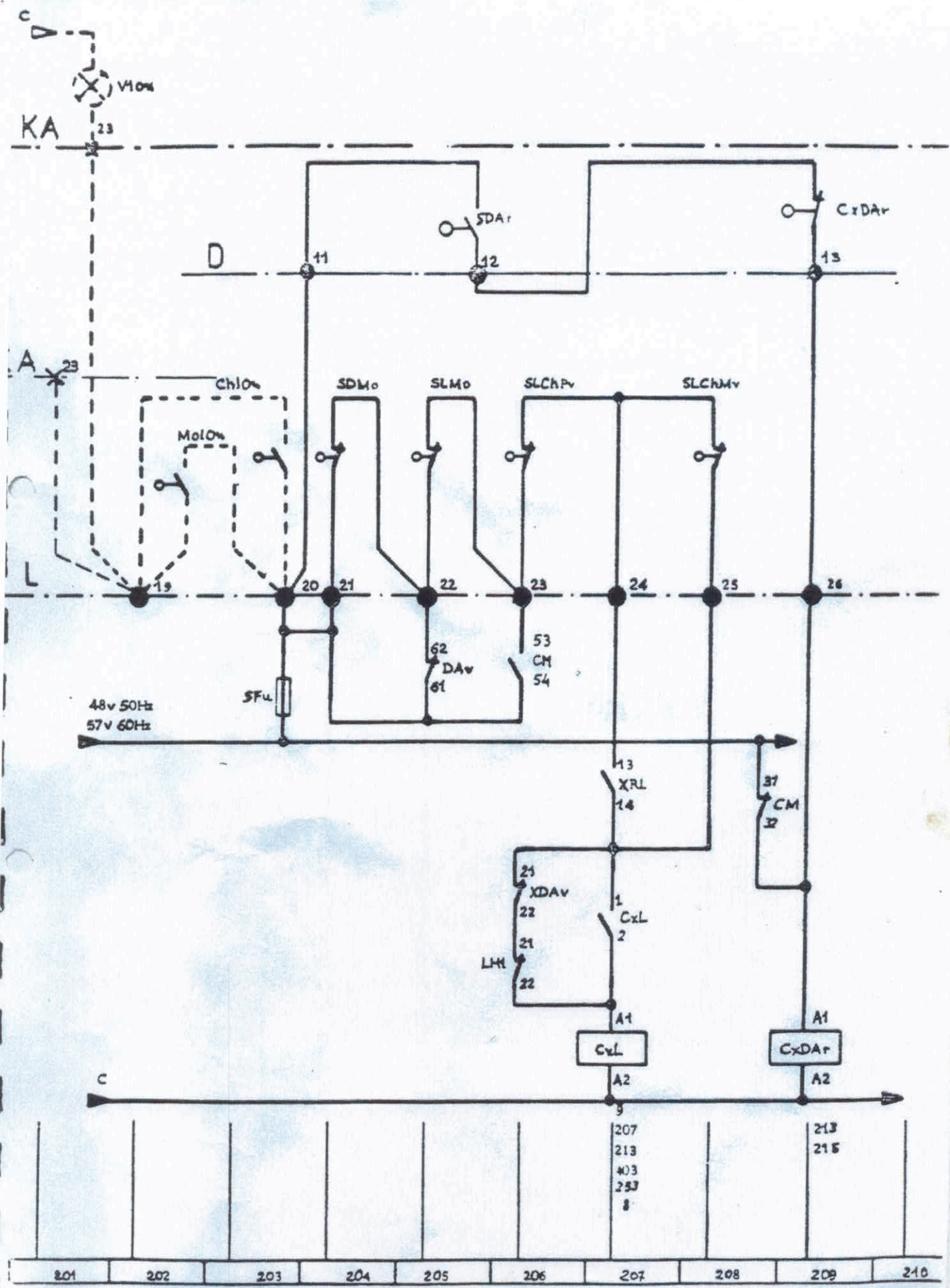

A 00 120 32 00



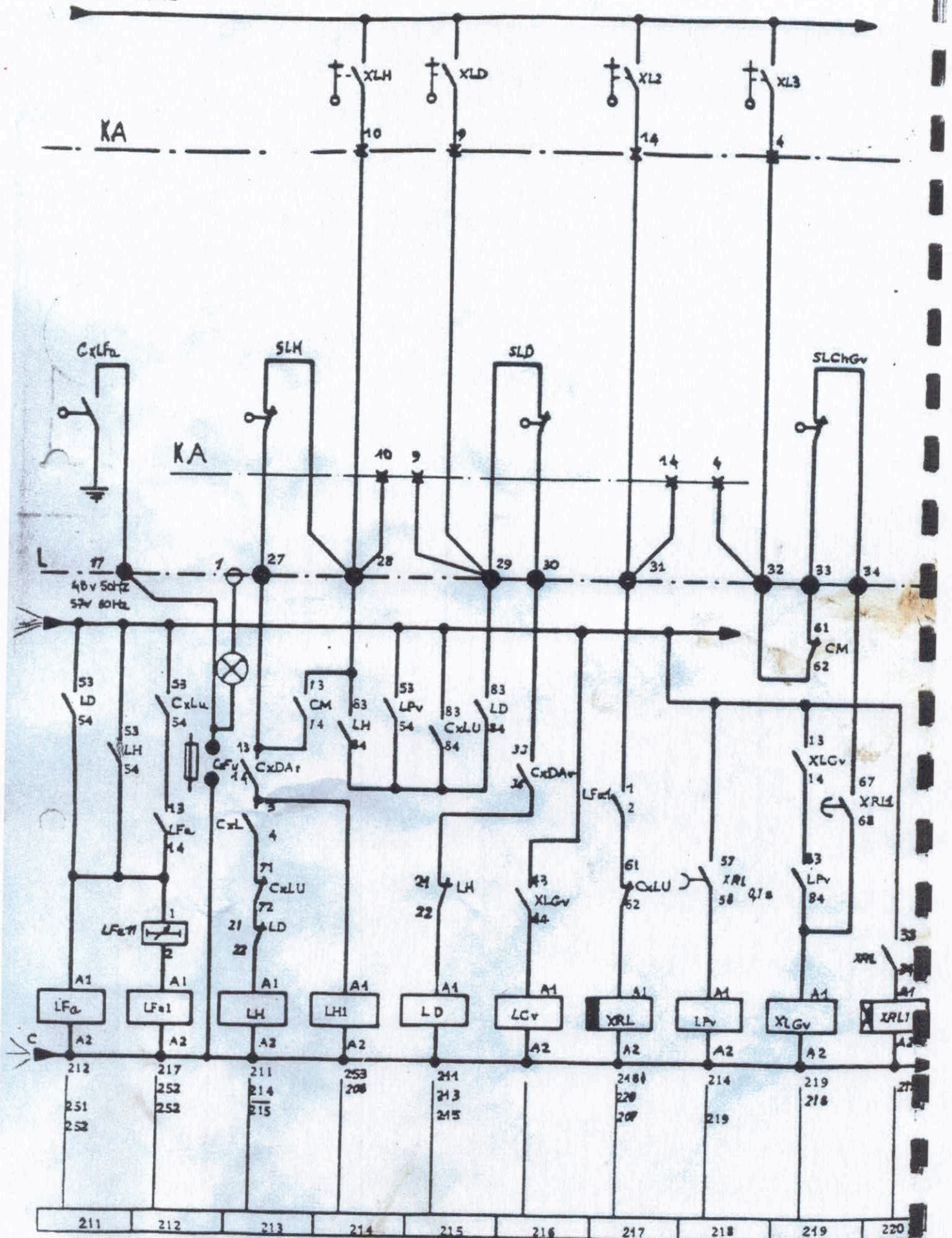

A 00 121 30 00







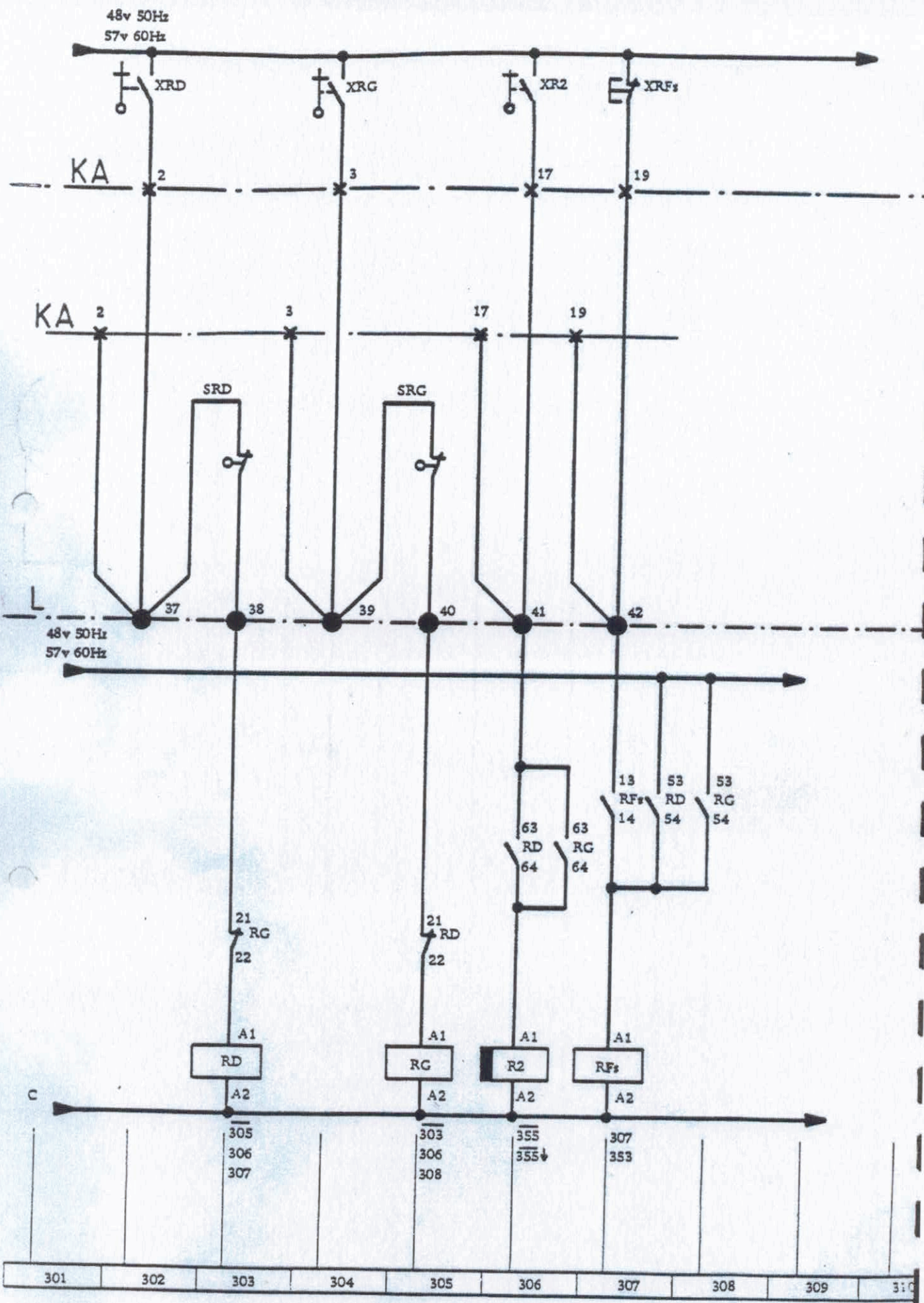

A 00 130 07 00

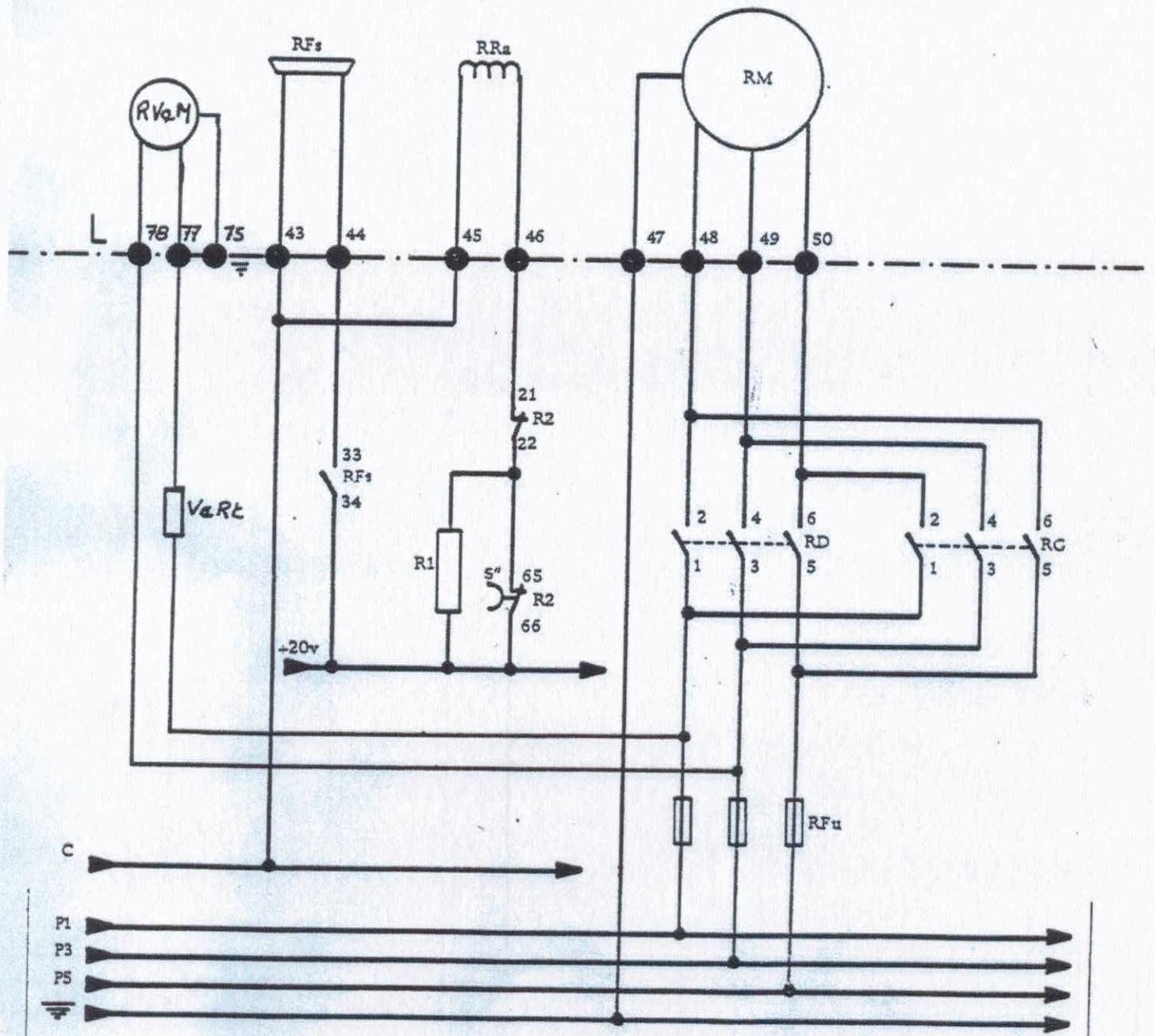

351      352      353      354      355      356      357      358      359      360

A 00 135 07 01



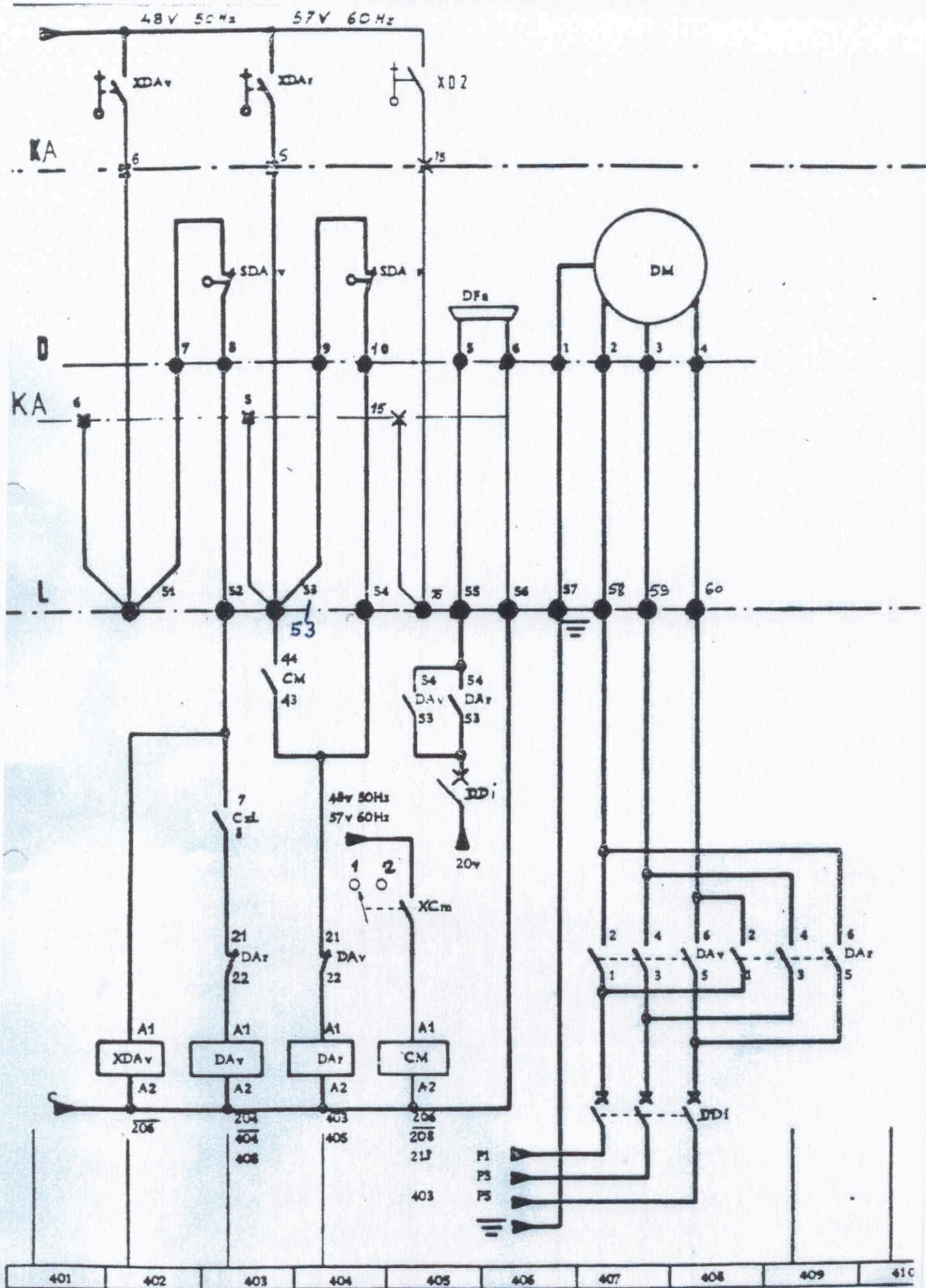

A 00 140 35 00



509 77

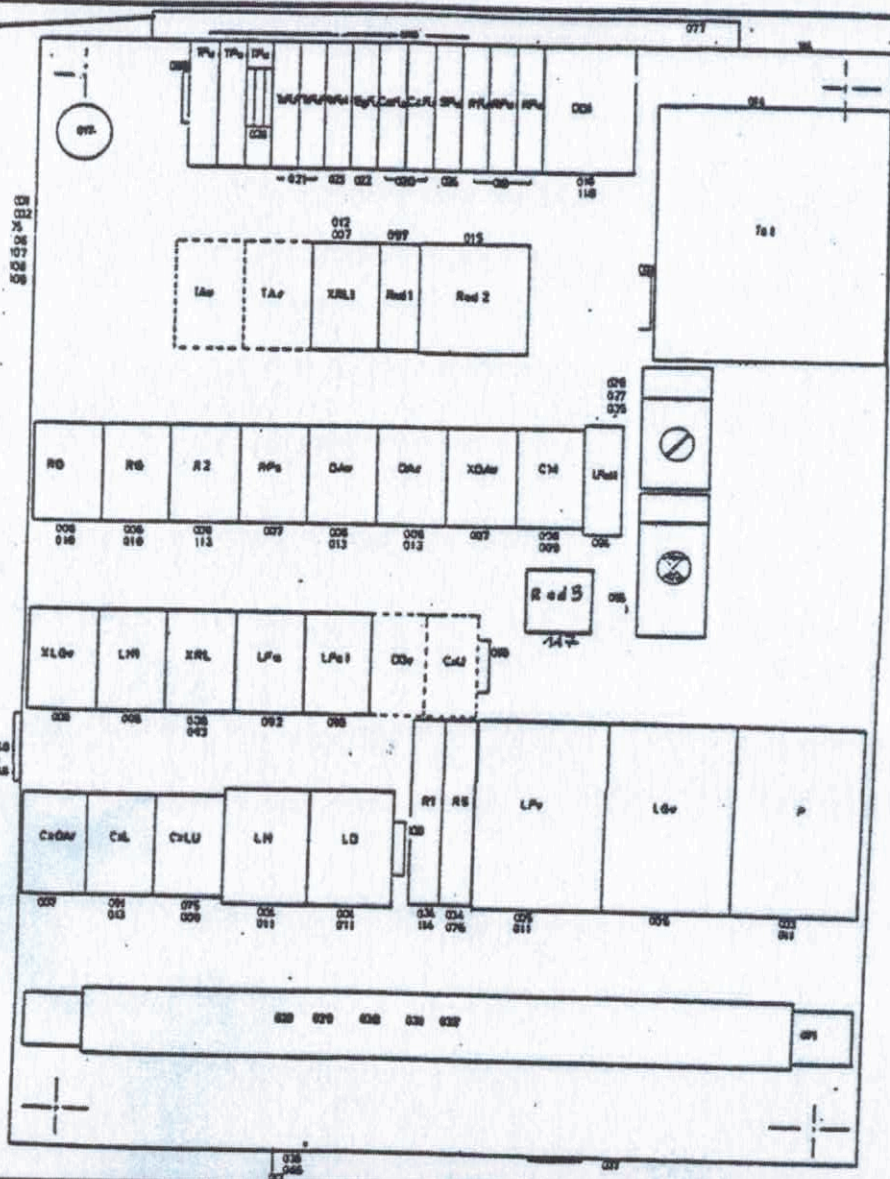

QTE S	DESIGNATION	BEZEICHNUNG	DESCRIPTION	DESI
	ARMOIRE PC15+P+RCO+DIV	SCHALTSCHRANK	CONTROL-PANEL	ARMARIO
1	Armoire nue 800x600	Schaltschrank	Control-panel	Armerio
1	Platine d'armoire elect	Schrankmontageplatte	Panel fixing plate	Quadro
1	Contacteur 4f 40a bob 48v	Kontaktgeber	Switch	Contacto
1	Bobine 48 v serie d40	Spule	Coil	Bobina
2	Contacteur 3x25a+ob48venc	Kontaktgeber	Switch	Contacto
2	Bobine 48 v	Spule	Coil	Bobina
2	Contacteur 2f+2o 40a b48v	Kontaktgeber	Switch	Contacto
2	Bobine 48 v serie d40	Spule	Coil	Bobina
5	Contacteur 3x9a+o b48venc	Kontaktgeber	Switch	Contacto



2010509 (77)

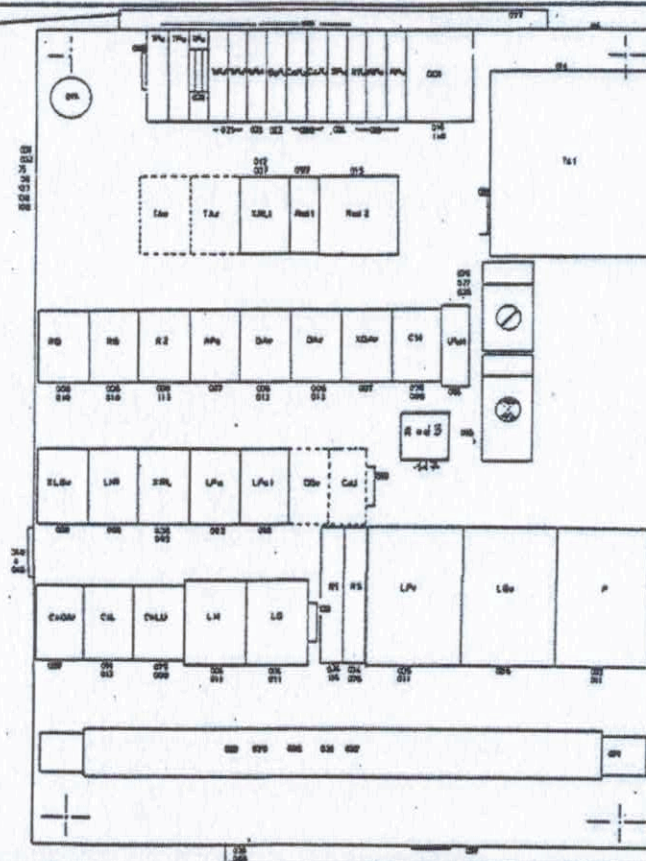

REP	REFERENCE	QTE	S	DESIGNATION	BEZEICHNUNG	DESCRIPTION	DESIGNACION
	G-58410-86			ARMOIRE PCL5+P+ROO+DIV	SCHALTSCHRANK	CONTROL-PANEL	ARMARIO
001	F-58410-39	1		Armoire rue 800x600	Schaltschrank	Control-panel	Armerio
002	N-58410-23	1		Platine d'armoire elect	Schrankmontageplatte	Panel fixing plate	Quadro armario
003	H-04411-70	1		Contacteur 4f 40a bob 48v	Kontaktgeber	Switch	Contacteur
003A	K-04411-95	1		Bobine 48 v serie d40	Spule	Coil	Bobina
004	Q-11411-13	2		Contacteur 3x25a+ob48venc	Kontaktgeber	Switch	Contacteur
004A	J-04411-94	2		Bobine 48 v	Spule	Coil	Bobina
	D-04411-66	2		Contacteur 2f+2o 40a b48v	Kontaktgeber	Switch	Contacteur
005A	K-04411-95	2		Bobine 48 v serie d40	Spule	Coil	Bobina
006	J-11411-07	5		Contacteur 3x9a+o b48venc	Kontaktgeber	Switch	Contacteur
006A	H-04411-93	5		Bobine 48 v	Spule	Coil	Bobina
007	U-11411-17	4		Relais aux 3f+1o b48v enc	Relais	Relay	Rele
007A	H-04411-93	4		Bobine 48 v	Spule	Coil	Bobina
008	T-11411-16	4		Relais aux 2f+2o b48v enc	Relais	Relay	Rele
008A	H-04411-93	4		Bobine 48 v	Spule	Coil	Bobina
009	F-04411-45	2		Bloc contacts 2f + 20	Bloc	Block	Bloque
010	F-04411-68	2		Bloc contact 2f	Bloc	Block	Bloque
011	G-04411-46	4		Bloc contacts 4f	Bloc	Block	Bloque
012	E-04411-47	1		Temporisateur travail 30s	Zeitschalter	Time-delay	Temporizador
013	E-04411-44	3		Bloc contacts f + o	Bloc	Block	Bloque
014	G-14406-11	1		Transfo 500va 3x24	Transformator	Transformer	Transformador
015	N-14406-17	1		Redresseur 16a positif	Gleichrichter	Rectifier	Rectificador corrien
015A	G-02412-76	1		Cartouche-fus 10x38 ur16a	Sicherungspatrone	Fuse cartridge	Cartucho fusible
015B	M-13412-79	2		Cartouche-fus 10x38gl 12a	Sicherungspatrone	Fuse cartridge	Cartucho fusible
016	A-13412-68	1		Disjoncteur 10-16a tri	Schutzschalter	Autom.circuitbreaker	Interruptor
017	E-00424-39	1		Resistance 100w 175	Widerstand	Resistance	Resistencia
018	Q-13412-59	10		Coupe-circuit 10,3x38	Ausschalter	Circuit-breaker	Corta-circuito
019	J-02412-55	6		Cartouche-fus 10x38 am12a	Sicherungspatrone	Fuse cartridge	Cartucho fusible
020	H-02412-54	4		Cartouche-fus 10x38 am10a	Sicherungspatrone	Fuse cartridge	Cartucho fusible
021	G-02412-53	4		Cartouche-fus 10x38 am6a	Sicherungspatrone	Fuse cartridge	Cartucho fusible



2010509 (77)

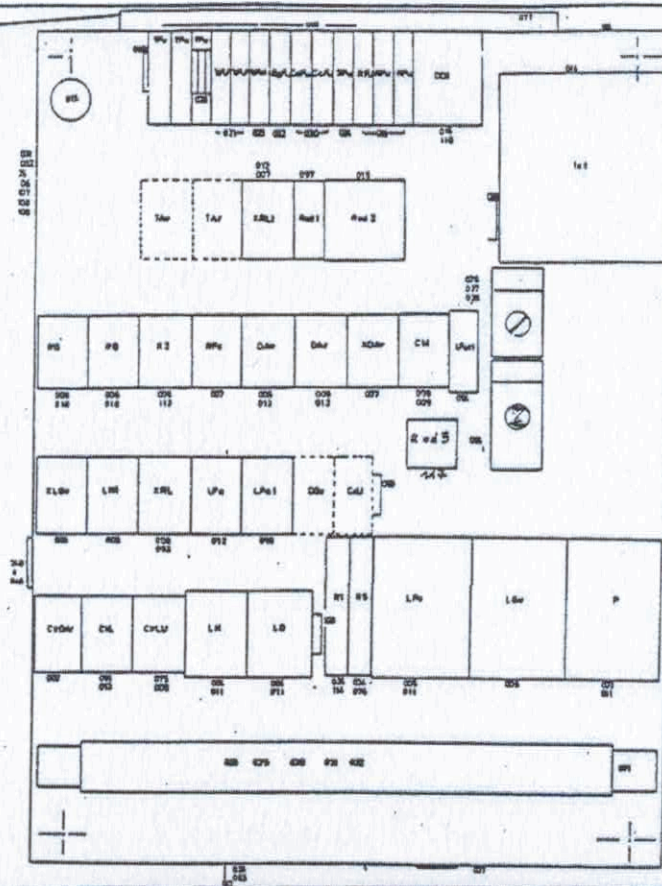

REP	REFERENCE	QTE S	DESIGNATION	BEZEICHNUNG	DESCRIPTION	DESIGNACION
J22	F-02412-52	2	Cartouche-fus 10x38 am 2a	Sicherungspatrone	Fuse cartridge	Cartucho fusible
J23	Q-02412-61	3	Cartouche-fus 10x38gl 16a	Sicherungspatrone	Fuse cartridge	Cartucho fusible
J24	N-02412-59	2	Cartouche-fus 10x38 gl 6a	Sicherungspatrone	Fuse cartridge	Cartucho fusible
J25	M-02412-58	1	Cartouche-fus 10x38 ur25a	Sicherungspatrone	Fuse cartridge	Cartucho fusible
J26	N-46413-43	1	Tete bouton tournant 2pos	Kopf	Head	Cabeza
J27	R-46413-46	1	Corps de bouton lf	Hauptstueck	Body	Cuerpo
J28	Q-08408-25	71	Borne vis 4mm2 pas 6	Anschlussklemme	Terminal	Borna
J29	L-08408-90	6	Borne vis 4mm protect p6	Anschlussklemme	Terminal	Borna
030	R-08408-26	2	Borne vis 6mm2 pas 8	Anschlussklemme	Terminal	Borna
031	8408-92	2	Borne vis 10mm protec p10	Anschlussklemme	Terminal	Borna
032	U-08408-29	2	Flasque borne 5000	Flansch	Flange	Cara
034	T-00424-75	2	Support resistance	Tragstueck	Support	Soporte
J35	P-02986-22	1	Tole support commutateur	Blech	Plate	Chapa
036	X-01417-01	1	Avertisseur 48v a embase	Hupe	Horn	Claxon
037	R-10041-03	1	Tube pass cable brut	Rohr	Pipe	Tubo
038	W-09414-56	2	Protecteur borne	Schutz	Protector	Protector
039	X-00027-58	0,1	Tube verre epoxy 6,2x12	Rohr	Pipe	Tubo
040	N-01407-26	1	Embase f 24x27a equ 0,8m	Socket	Socket	Asiento
041	W-02259-72	1	Tole protection	Blech	Plate	Chapa
042	V-01382-26	2	Ressort	Feder	Spring	Muelle
043	X-37460-77	1	Joint-caoutch	Gummidichtung	Rubber seal	Junta-goma
044	A-02407-18	1	Bouchon connecteur	Stopfen	Plug	Tapon
045	Z-47413-34	1	Bouchon shunt	Stopfen	Plug	Tapon
045A	K-02407-04	1	Connecteur m24x27a	Steckverbindung	Connector	Conector
046	F-02407-46	2	Detrompeur-connecteur	Steckerfuehrung	Connector guide	Guia conector
047	U-40475-35	1	Plaque-instruction	Hinweisschild	Indicating plate	Placa instrucciones
048	Q-18475-35	1	Plaque code serie	Platte	Plate	Placa
049	X-73475-09	1	Adhesif eclair	Aufkleber	Adhesive	Adhesivo
050	N-33410-61	1	Vide-poche amoire elect	Ablage	Cubbyhole	Guantero
051	M-02520-91	1	Clef manoeuvre	Schluessel	Spanner	Llave
052	X-00336-01	4	Boulon h max15 c15-6	Bolzen	Bolt	Tornillo



2010509 77

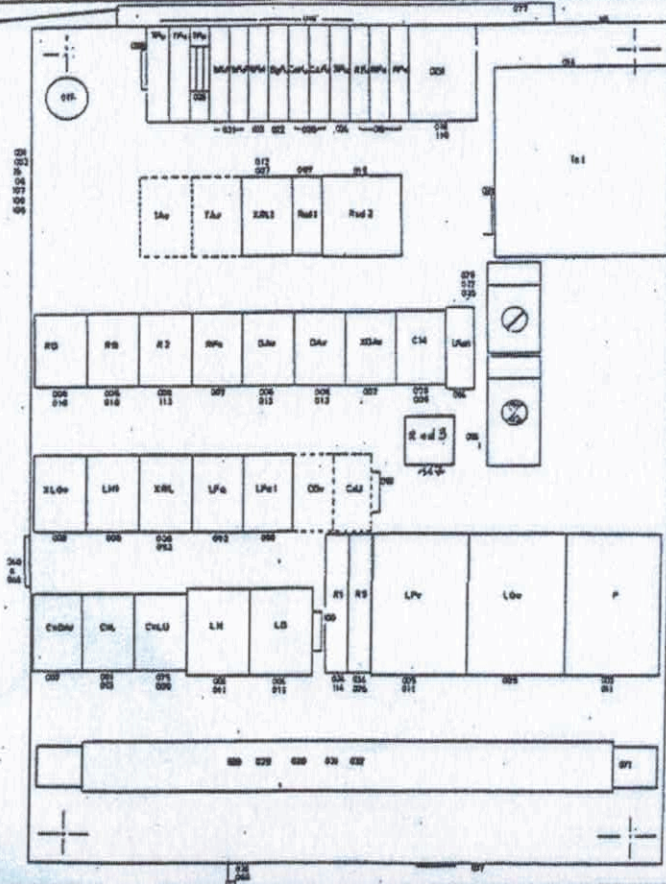

REP	REFERENCE	QTE	S	DESIGNATION	BEZEICHNUNG	DESCRIPTION	DESIGNACION
053	G-00336-78	1		Boulon h m6x50 c15-6	Bolzen	Bolt	Tornillo
054	M-00325-56	6		Vis cb m4x20 nylon	Schraube	Screw	Tornillo
055	A-00347-07	5		Rondelle w6	Scheibe	Washer	Arandela
056	X-11330-93	21		Vis sp	Schraube	Screw	Tornillo
057	V-18345-45	2		Ecrou m6 pour din 35	Mutter	Nut	Tuerca
058	H-00325-29	8		Vis cb m4x16 c15-6	Schraube	Screw	Tornillo
059	E-10045-98	8		Fil h07 vk 1,5 orange	Draht	Wire	Hilo
060	T-12045-04	50,5		Fil h 07 vk 1,5 rouge	Draht	Wire	Hilo
061	Z-00045-53	27,5		Fil h07 vk 2,5 noir	Draht	Wire	Hilo
062	U-12045-05	4		Fil h 07 vk 2,5 rouge	Draht	Wire	Hilo
063	C-10045-27	0,8		Fil h07 vk 2,5 v.j	Draht	Wire	Hilo
064	D-10045-28	2,4		Fil h07 vk 6 v.j	Draht	Wire	Hilo
065	F-10045-07	0,8		Cable u 750 csv 30 2xl	Kabel	Cable	Cable
066	J-01442-41	1		Caisse carton 189x77x60	Kiste	Box	Caja
067	T-01409-38	3		Clip femelle	Clip	Clip	Anillo-de-reten
068	T-28414-14	45		Passe-fil de 18	Drahtdurchfuehrung	Guide	Pasacable
069	N-02986-21	1		Plaque d'obturation	Platte	Plate	Placa
071	R-02986-24	1		Profil din 35 sp 1550	Profilstueck	Profile	Perfil
072	G-10410-09	3		Support bornier	Tragstueck	Support	Soporte
073	C-02986-34	1		Plaque d'obturation	Platte	Plate	Placa
074	C-04345-64	6		Ecrou hm4 nylon	Mutter	Nut	Tuerca
075	R-11411-60	1		Contacteur 4x12a b220 enc	Kontaktgeber	Switch	Contactor
075A	H-11411-75	1		Bobine 220v (9-16)	Spule	Coil	Bobina
076	U-00424-07	1		Resistance 28w 1800 ohms	Widerstand	Resistance	Resistencia
077	H-58410-87	1	R	COFFRET DE RESISTANCES EQ	SCHALKASTEN	ELECTRICAL CABINET	COFRE
078	F-03406-66	1		Limiteur surtension 480v	Kaefiglaeufermotor	Squirrel cage motor	Motor jaula ardilla
080	V-00283-32	4		Vis h m6x20 c15-6	Schraube	Screw	Tornillo
081	C-00341-11	4		Ecrou h m6 c1 56	Mutter	Nut	Tuerca
082	H-01414-34	1		Presse-étoupe laiton 21	Stopfbuechse	Packing gland	Prensaestopas
083	U-00350-01	8		Rondelle m 6 n	Scheibe	Washer	Arandela
084	S-13045-53	3		Fil special 2,5mm	Draht	Wire	Hilo



2010509 77

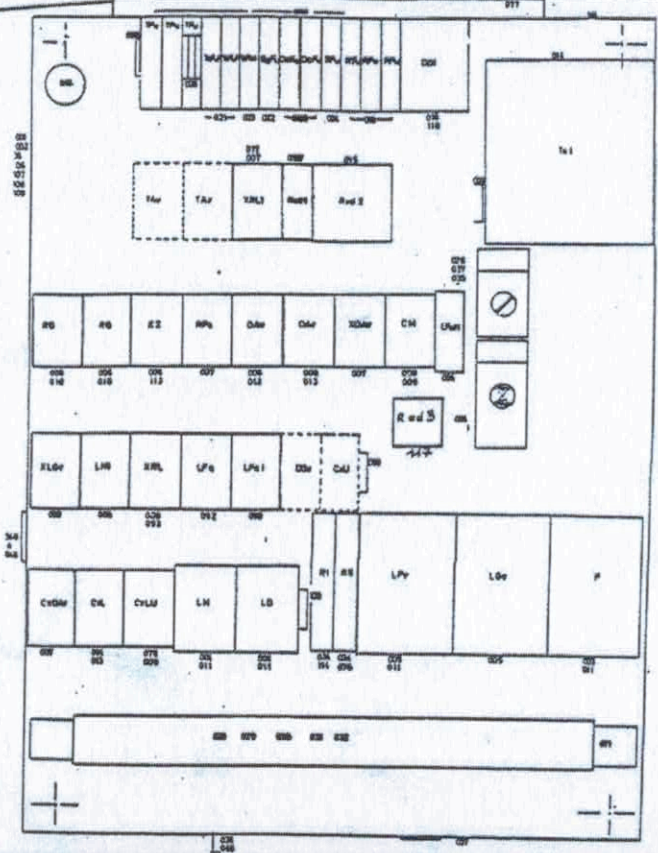

REP	REFERENCE	QTE S	DESIGNATION	BEZEICHNUNG	DESCRIPTION	DESIGNACION
085	L-00348-09	4	Rondelle 6	Scheibe	Washer	Arandela
086	C-01414-52	1	Ecrrou-presse-estoupe 21	Stopfbuchsenmutter	Packing gland	Tuerca prensa-estopa
087	W-08408-31	1	Butee d'arret borne	Anschlag	Stop	Tope
088	X-00341-07	8	Ecrrou h m4 cl 56	Mutter	Nut	Tuerca
090	W-11411-19	1	Contacteur 12a 2o2fb48enc	Kontaktgeber	Switch	Contacteur
090A	H-04411-93	1	Bobine 48 v	Spule	Coil	Bobina
091	H-11411-06	1	Contacteur 4x9a b48v enc	Kontaktgeber	Switch	Contacteur
091A	H-04411-93	1	Bobine 48 v	Spule	Coil	Bobina
091B	-11411-08	1	Contacteur 4x12a b48v enc	Kontaktgeber	Switch	Contacteur
092A	H-04411-93	1	Bobine 48 v	Spule	Coil	Bobina
093	F-11411-73	1	Temporisateur r 0-3s	Zeitschalter	Time-delay	Temporizador
094	D-11411-71	1	Temporisateur el t 0,3s	Zeitschalter	Time-delay	Temporizador
096	T-58410-28	1	Voyant indicateur	Kontrollampe	Control lamp	Indicador luminoso
097	W-14406-71	1	Bloc diodes	Block	Block	Bloque
098	Z-11330-94	4	Vis sp	Schraube	Screw	Tornillo
099	V-02986-51	3	Profil din 35 sp 1300	Profilstueck	Profile	Perfil
100	Z-02986-54	1	Profil din 35 sp 1250	Profilstueck	Profile	Perfil
101	U-02986-96	1	Profil din 35 sp 1375	Profilstueck	Profile	Perfil
104	A-15031-19	0,1	Joint cabine	Dichtung	Seal	Junta
105	D-02031-62	2,7	Joint mousse 25x10 adh	Dichtung	Seal	Junta
106	A-58410-11	1	Came	Nocken	Cam	Leva
107	P-00341-68	1	Ecrrou h m4 cl 56	Mutter	Nut	Tuerca
108	E-09520-20	1	Poignee a condamnation	Griff	Handle	Empunadura
109	X-09475-52	1	Plaque-instruct	Hinweisschild	Indicating plate	Placa instrucciones
110	R-11411-37	1	Bloc de contact o + f	Block	Block	Bloque
113	J-04411-48	1	Temporisateur repos 30s	Zeitschalter	Time-delay	Temporizador
114	U-00424-99	1	Resistance 16w 15	Widerstand	Resistance	Resistencia
115	V-14285-49	4	Entretoise 17,2 ep2 130	Distanzstueck	Spacer	Distanziador
116	X-18345-47	4	Ecrrou m6 3lx20	Mutter	Nut	Tuerca
117	H-15406-39	1	Redresseur frein 220v	Gleichrichter	Rectifier	Rectificador corrien