

TOPMATIC 320A

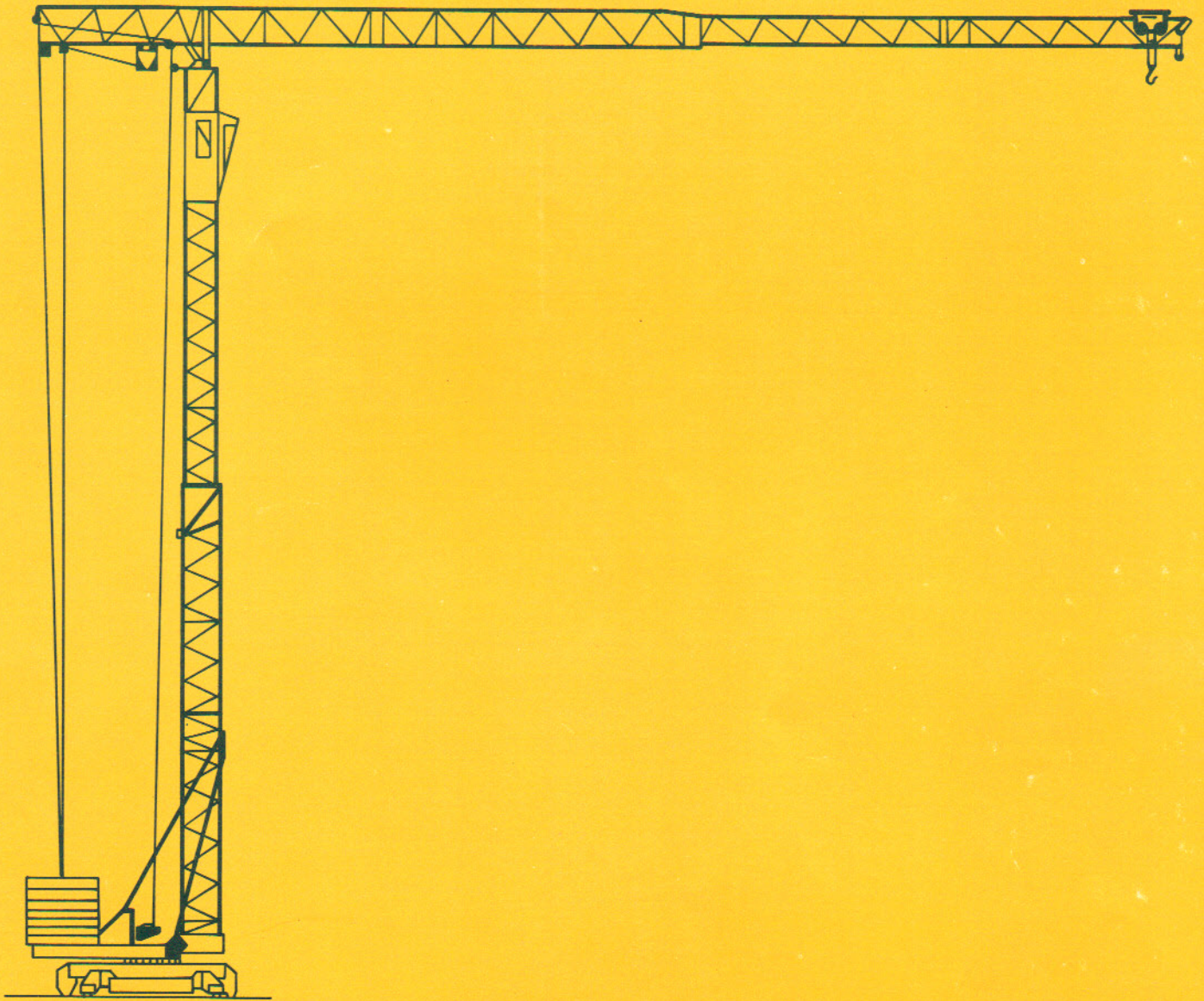

TOPMATIC 320A

Potain



Potain TOPMATIC 320A

Cotes Abmessungen Dimensions Dimensiones

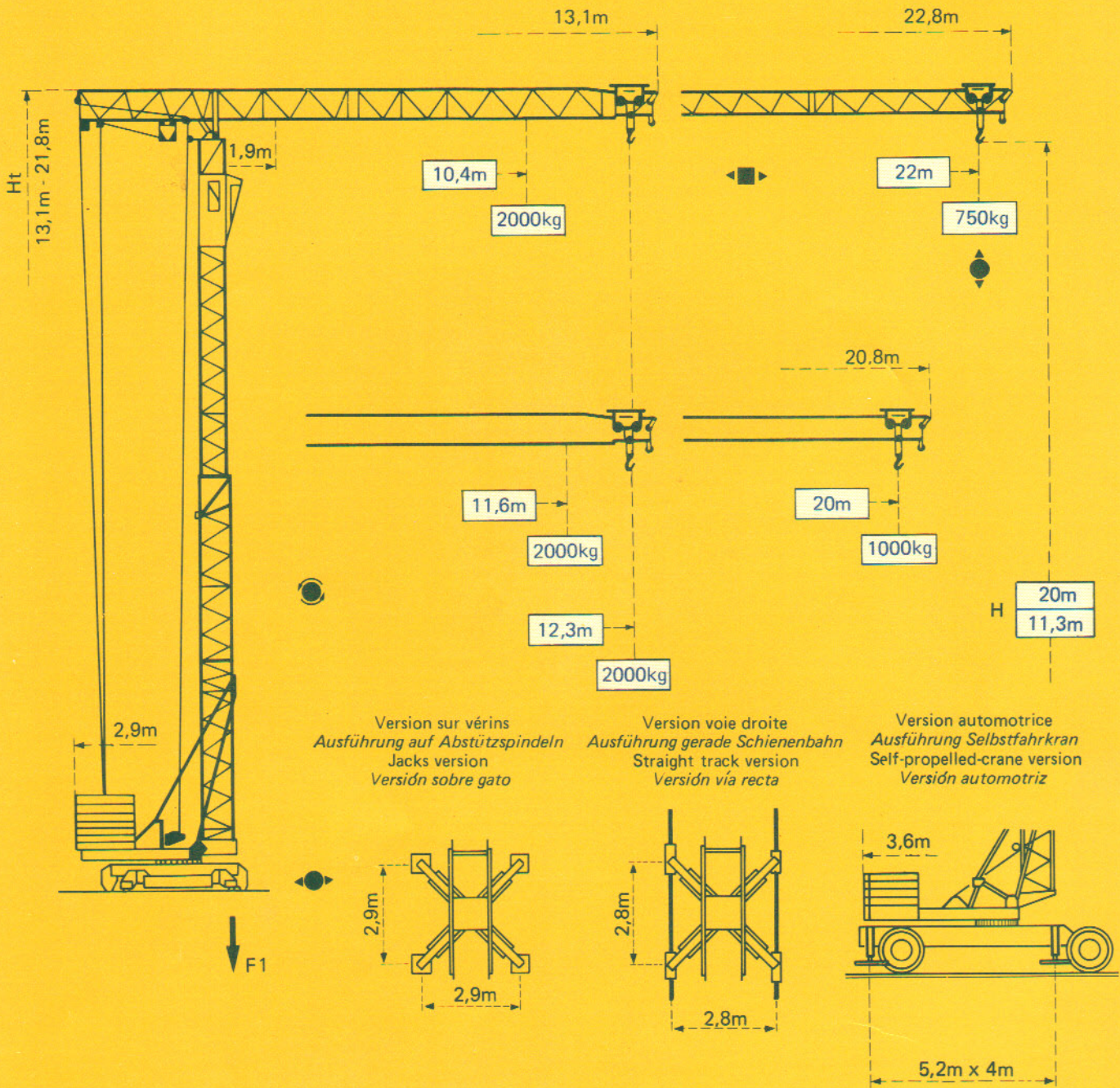

Version sur vérins
Ausführung auf Abstützspindeln
Jacks version
Versión sobre gato

Version voie droite
Ausführung gerade Schienenbahn
Straight track version
Versión vía recta

Version automotrice
Ausführung Selbstfahrkran
Self-propelled-crane version
Versión automotriz

F1 = Réactions Eckdrücke Reactions Reacciones

F1	● 109,1 kN	■ 63,1 kN
	8,2 t	

● En service
■ Hors service

A vide sans lest ni train de transport, avec flèche et hauteur maximum.

● In Betrieb
■ Ausser Betrieb

Ohne Last, Ballast und Transportachse, mit Maximalausleger und Maximalhöhe.

● In service
■ Out of service

Without load, ballast or transport axles, with maximum jib and maximum height.

● En servicio
■ Fuera de servicio

Sin carga, sin lastre, ni tren de transporte, flecha y altura máximas.

Courbes de charges Lastkurven Load curves Curvas de cargas

 Flèche Ausleger Jib Flecha

1,9	→	10,4	11	12	13	14	15	16	17	18	19	20	21	22	m
22m		2000	1860	1670	1510	1370	1250	1150	1060	990	920	860	800	750	kg

1,9	→	11,6	12	13	14	15	16	17	18	19	20	m
20m		2000	1920	1740	1580	1450	1340	1240	1150	1070	1000	kg

1,9	→	12,3	m
12,3m		2000	kg

Flèche relevée Ausleger in Steilstellung Raised jib Flecha izada



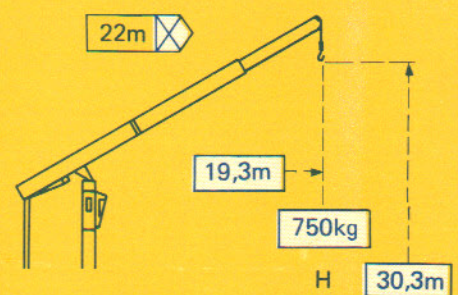
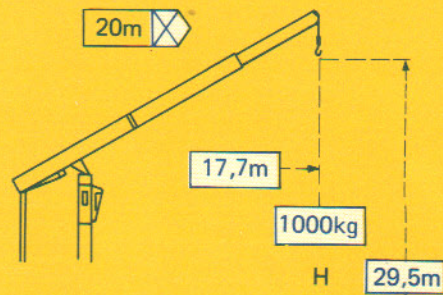



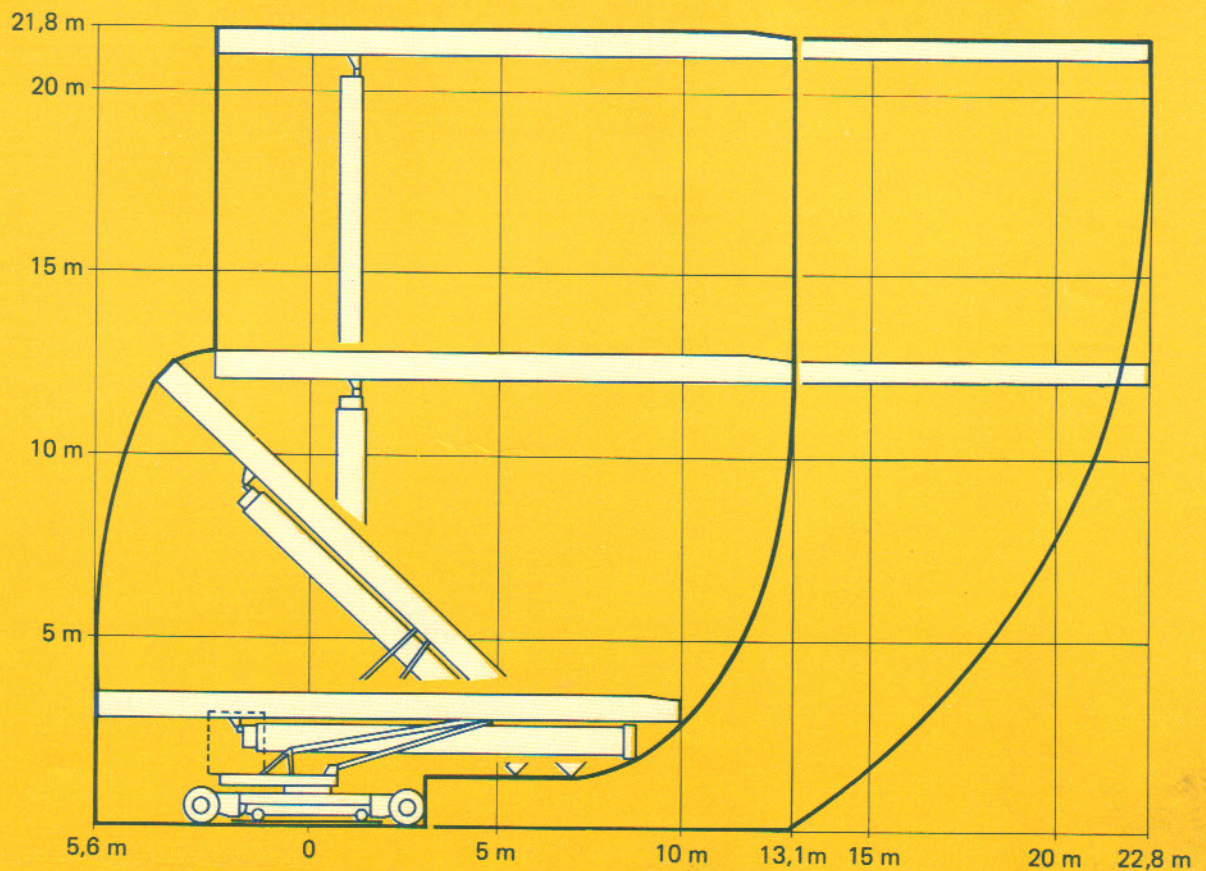





Chariot bloqué
(version standard)
Verriegelte Laufkatze
(Standardausführung)
Trolley locked
(standard crane)
Carro bloqueado
(version standard)



Montage Montage Erection Montaje



Mécanismes Antriebe Mechanisms Mecanismos

			m/min.	kg	ch-PS hp	kW
Levage Heben Hoisting Elevación	 15TD PC 5 		4,8	2000	3,5	2,7
			22,5	2000	15	11
			45	1000		
Distribution - Katzfahren Trolleying - Distribución		DV 31	32		4	2,9
Orientation - Schwenken Slewing - Orientación		MCS 20	0,3 - 1 tr/min U/min-rpm		2	1,2
Translation - Kranfahren Travelling - Traslación		TVD 221	30		2 x 1,5	2 x 1
Puissance électrique nécessaire Anschlusswert Necessary electric power Potencia electrica necesaria	380 V 50 HZ 	Réseau - Netzstrom Mains supply - Red			20 kVA	
		Groupe électrogène Stromaggregat Generator set Grupo electrogeno			Nous consulter Auf Anfrage Consult us Consultarnos	

Transport Transport Transport Transporte

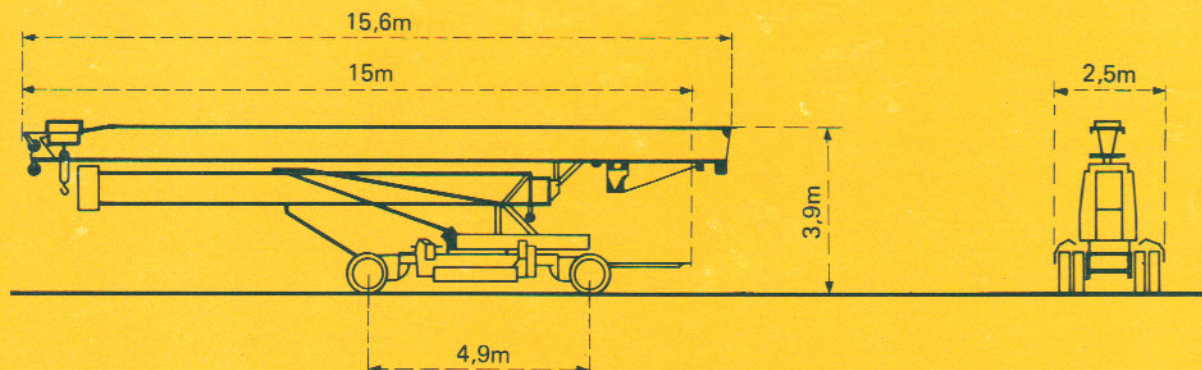

Version tractée derrière camion
 Ausführung als LKW-Anhänger
 Lorry towed version
 Versión remolcable detrás de un camión

DIN 15018 H1 B3

 **Potain**

18, rue de Charbonnières B.P 173 - F 69130 ECULLY
 Tél. (7) 833.81.81 Télex 330 179
 EXPORT. 89 Av. du Pdt Roosevelt - CHEVILLY - LARUE
 F 94150 RUNGIS - Tél. (1) 687.22.23 - Télex 270001
 POTAIN GmbH - D 6082 MÖRFELDEN - WALLDORF
 Nordendstr. 79-87 - Postfach 420 - Tel. (6 105) 5091 - Telex 4 185745
 POTAIN SUISSE S.A. - CH 5115 MÖRIKEN WILDEGG
 Tel. 64.53.19.91 - Telex 68294

Modifications réservées - Änderungen vorbehalten - Subject to modification - Modificaciones reservadas
 Ref. 8036 EYD
 Printed in France