

**CITY CRANE MD 90** DIN

**POTAIN**  ®

**CITY  $\square$  1,60m**

Mat - Mast - Mast - Mástil - Torre

KM 406 E 

$H_{\square} = H_{\square} / \square + 0,3m$

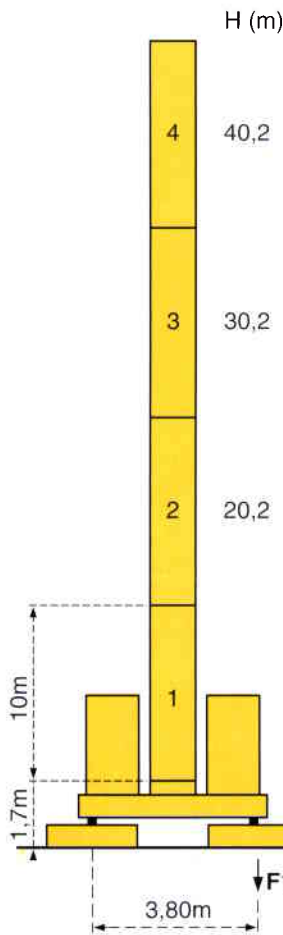

**ZC 40 A**

F1	● 52t	■ 56t
	32t	

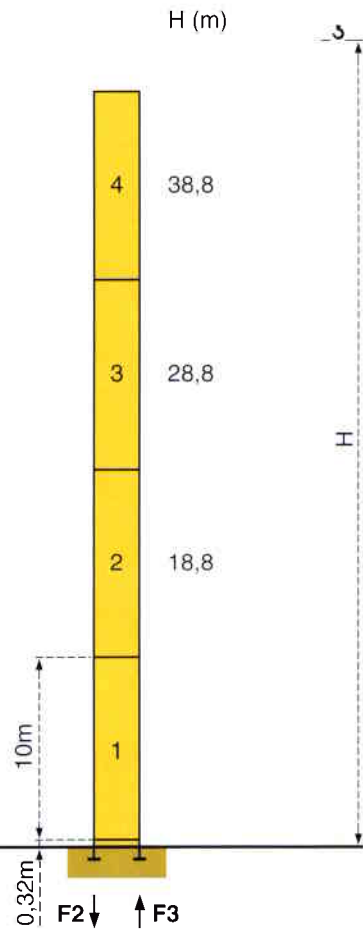

**P 40 A**

F2	● 45t	■ 55t
F3	● 70t	■ 78t
	28t	

**ZC 40A**

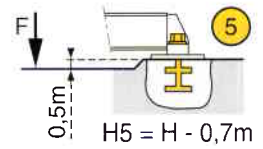
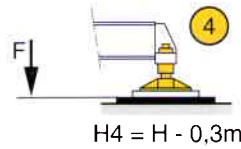
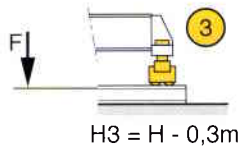
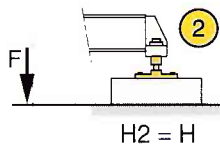
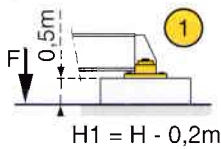

- En service
- Hors service

- In Betrieb
- Ausser Betrieb

- In service
- Out of service

- En servicio
- Fuera de servicio

- In servizio
- Fuori servizio

A vide sans lest avec flèche et hauteur maximum.



























Ohne Last und Ballast mit Maximalausleger und Maximalhöhe.

Without load and ballast with longest jib and maximum height.

Sin carga, sin lastre con flecha y altura máxima.

A vuoto senza zavorra e con braccio massimo e altezza massima.

Mécanismes - Antriebe - Mechanisms - Mecanismos - Meccanismi

				m/min	t		ch -PS hp	kW	
<p>Levage Heben Hoisting Elevación Sollevamento</p>	<p>33PC15/1</p> 			7	3	405 m > 405 m*	33	24	
				38,5	3				
				77	1,5				
				3,5	6				
				19	6				
				38,5	3				
	<p>33LVF15</p> 			4,6	3		405 m > 405 m*	33	24
				13	3				
				38,5	3				
				77	1,5				
				2,3	6				
				6,5	6				
				19	6				
				38,5	3				
<p>Distribution - Katzfahren - Trolleying Distribución - Distribuzione</p>		4 D3 V3	<p>15 30 58</p>			4	3		
<p>Orientation - Schwenken - Slewing Orientación - Rotazione</p>		RCV 80	<p>0 → 0,8 tr/min U/min-rpm</p>			2 x 6	2 x 4,4		
<p>Translation Kranfahren Travelling Traslación Traslazione</p>	<p>ZC40A</p> 	RT 224	25			2 x 4	2 x 2,9		
	<p>S 40 A</p> 	RT 324	12,5 - 25			2 x 7	2 x 5,2		
	<p>TCV 449 ARC H ≤ 34,7 m</p>		10 - 50			4 x 6,8	4 x 5		
	<p>S 41 A</p> 	RT 443 A1 2V	15 - 30			4 x 5	4 x 3,7		
	<p>TCV 449 ARC H ≤ 34,7 m</p>		10 - 50			4 x 6,8	4 x 5		
Réseau - Netzstrom - Mains supply - Red - Rete elettrica							380V-400V.50Hz		
Puissance électrique nécessaire - Anschlusswert - Necessary electric power Potencia eléctrica necesaria - Potenza elettrica necessaria							33 PC : 50 kVA 33 LVF : 50 kVA		
Groupe électrogène - Stromaggregat - Generator set - Grupo electrogeno - Gruppo elettrogeno							*		

\*Nous consulter - Auf Anfrage - Consult us - Consultarnos - Consultateci

Conforme aux directives CEE 84/534 et 87/405 sur le niveau acoustique - Gemäss EWG-Richtlinien 84/534 und 87/405 für den Schall- Leistungspegel  
In compliance with the EEC 84/534 and 87/405 instructions on noise level - Conforme con las directivas CEE 84/534 y 87/405 sobre el nivel acustico  
Conforme alle direttive CEE 84/534 e 87/405 sul livello acustico



**TELESCOPABLE - TELESKOPIERBAR - TELESCOPIC - TELESCOPICO - TELESCOPICO**

**Mats - Maste - Masts - Mástil - Torre**

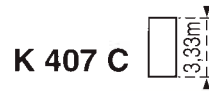
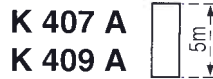
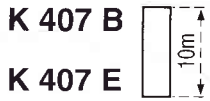

$H_{\square} = H_{\square} / \square + 0,3 \text{ m}$

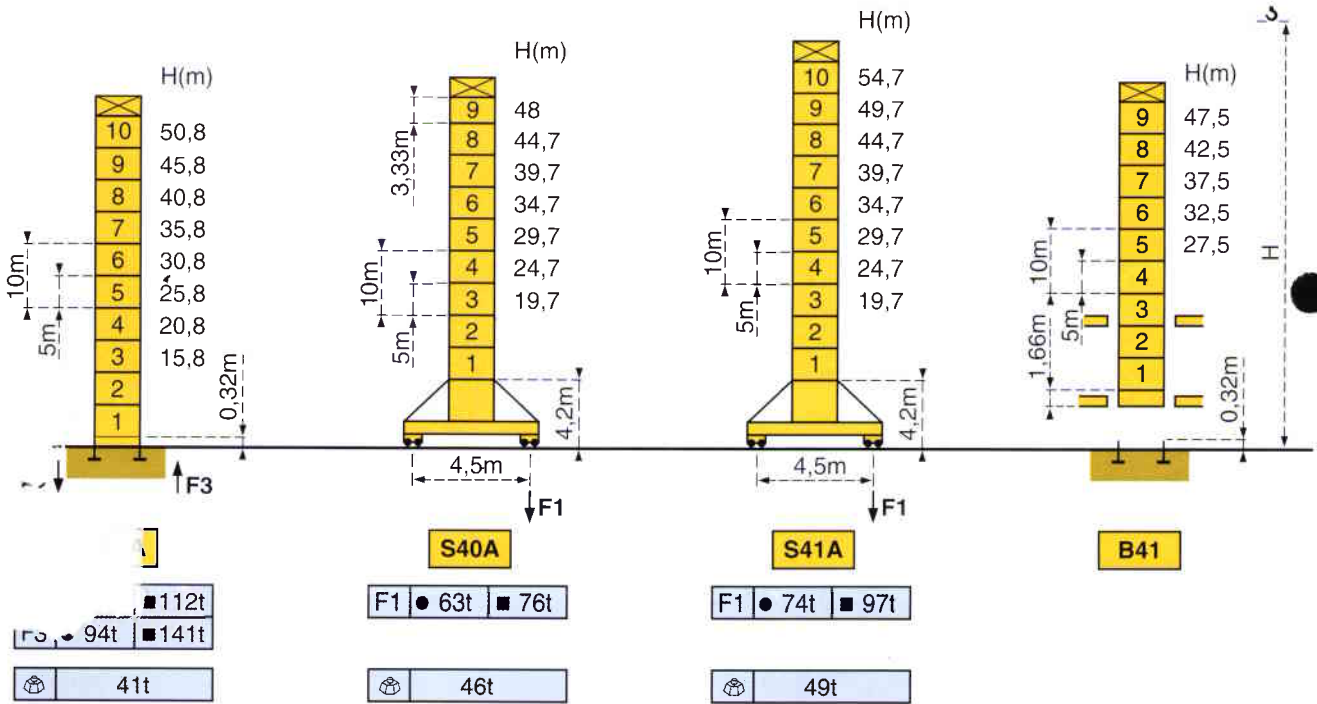

**Télescopage sur dalles - Kletterkrane im Gebäude - Climbing crane  
Telescopage gruas trepadoras - Gru in cavedio**

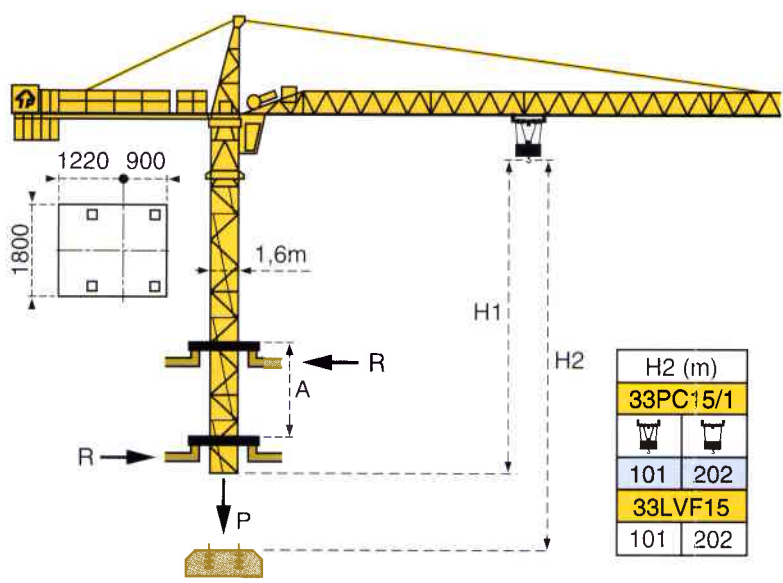

H2 (m)	
101	202
33LVF15	
101	202

**B41**

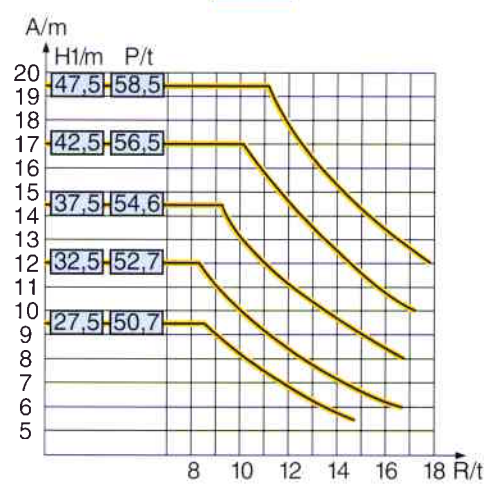

- |                                 |                               |                             |                                 |                                |
|---------------------------------|-------------------------------|-----------------------------|---------------------------------|--------------------------------|
| A Distance entre cadres         | A Abstand zwischen den Rahmen | A Distance between collars  | A Distancia entre marcos        | A Distanza fra i telai         |
| H1 Hauteur grue                 | H1 Kranhöhe                   | H1 Crane height             | H1 Altura grúa                  | H1 Altezza gru                 |
| P Poids de la grue (en service) | P Krangewicht (in Betrieb)    | P Crane weight (in service) | P Peso de la grúa (en servicio) | P Peso della gru (in servizio) |
| R Réaction horizontale          | R Horizontalkräfte            | R Horizontal reaction       | R Reaccion horizontal           | R Reazione orizzontale         |

# Courbes de charges - Lastkurven - Load diagrams - Curvas de cargas - Curve di carico

 Flèche Ausleger Jib Flecha Braccio

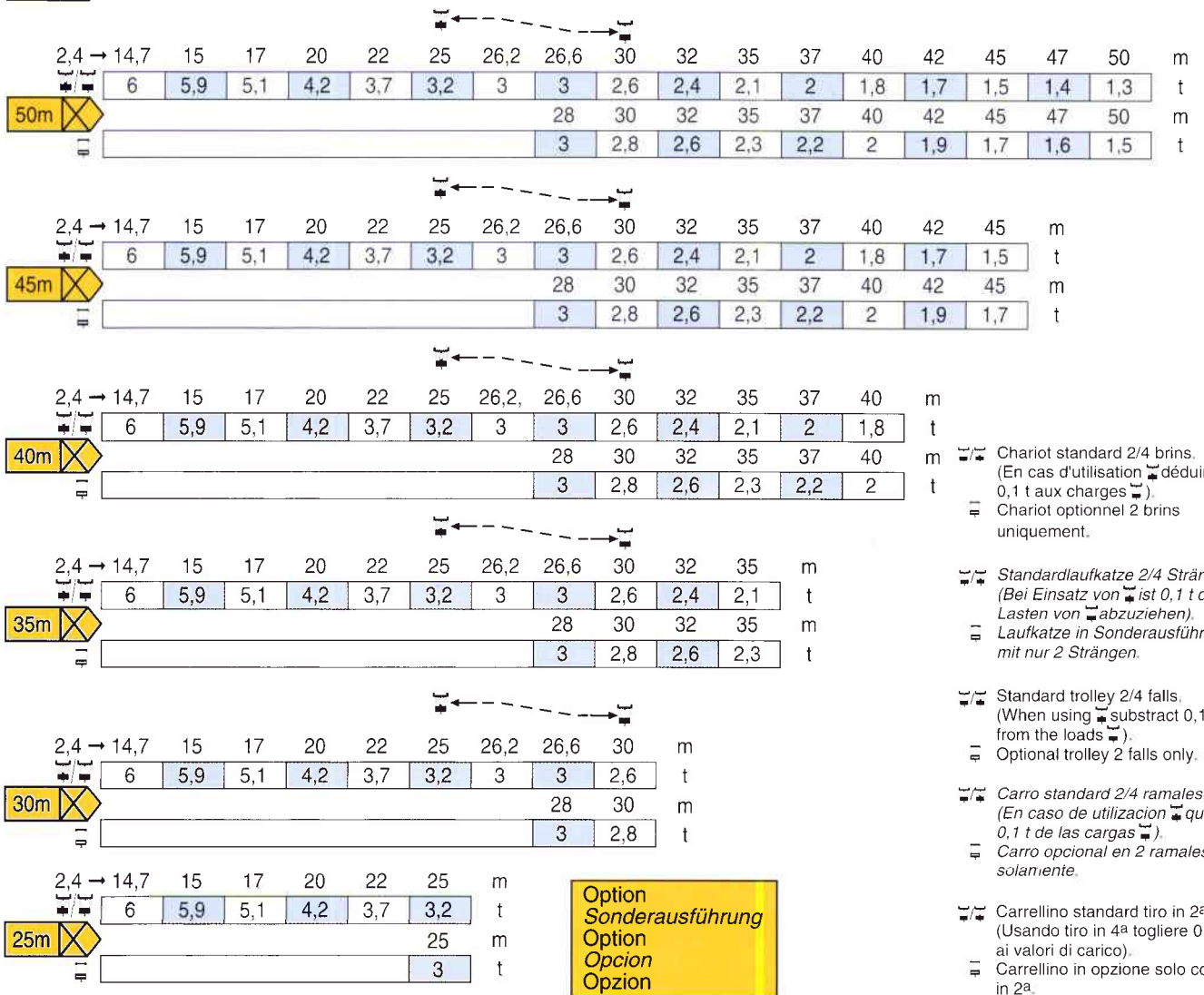

## Lest de contre-flèche - Gegenauslegerballast - Counter-jib ballast Lastre de contra flecha - Contrappeso

Crane Length	Counter-jib Length	Weight (kg)
50m	12,7m	16 300 (4x3400)+(1x2700)
45m	12,7m	14 900 (2x3400)+(3x2700)
40m	12,7m	13 600 (4x3400)
35m	12,7m	12 900 (3x3400)+(1x2700)
30m	12,7m	11 500 (1x3400)+(3x2700)
25m	12,7m	9 500 (2x3400)+(1x2700)

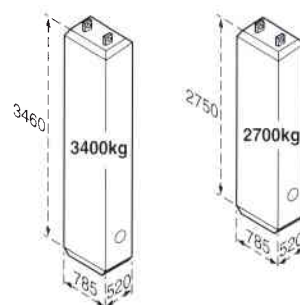

## Lest de base - Grundballast - Base ballast - Lastre de base - Zavorra di base

H (m)	Crane Type		H (m)	Crane Type		H (m)	Crane Type	
	50→40m	32→25m		50→40m	32→25m		50→40m	32→25m
						54,7	102t	108t
			48	78t	84t	49,7	84t	90t
			44,7	66t	72t	44,7	66t	72t
40,2	60t	65t	39,7	48t	54t	39,7	48t	54t
			34,7	30t	36t	34,7	30t	36t
30,2	40t	40t	29,7	24t	24t	29,7	24t	24t
			24,7	18t	18t	24,7	18t	18t
20,2	35t	35t	19,7	18t	18t	19,7	18t	18t
ZC 40 A ◀●▶			S 40 A ◀●▶			S 41 A ◀●▶		

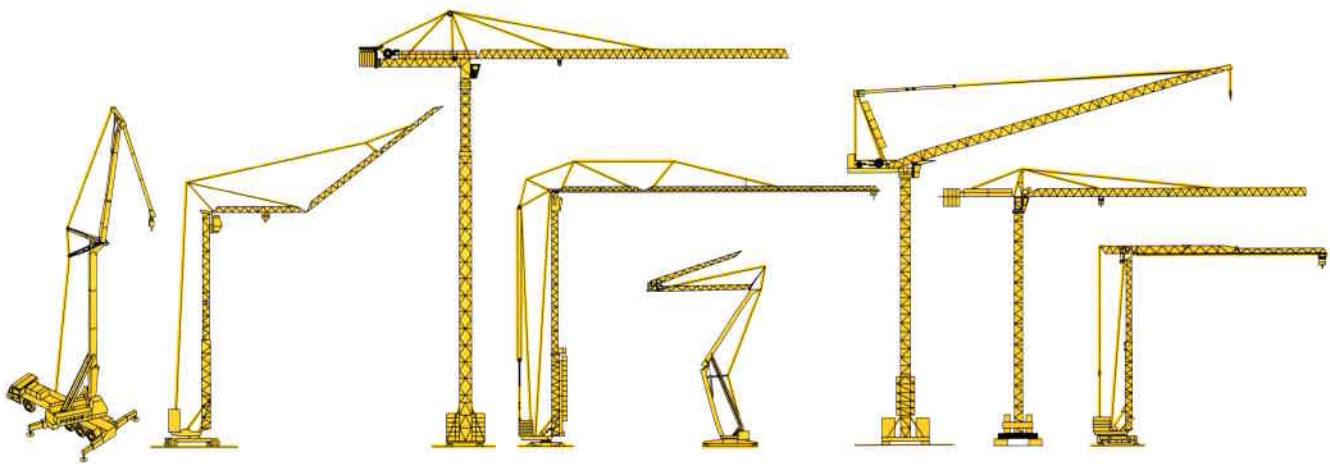

Document pour usage commercial uniquement - Benutzung dieser Unterlagen nur für Verkaufszwecke - Document for commercial use only -  
 Documento para uso comercial unicamente - Documento per uso commerciale solamente

Copyright.Reproduction interdite © POTAIN 1994

**POTAIN** 

**GRUPE LEGRIS INDUSTRIES**

18.Rue de Charbonnières, B.P. 173-F 69132 ECULLY Cedex  
 Tél. 72.20.20.20 - Télex 375 213 - Fax 72.20.20.00

POTAIN GmbH	Deutschland	Tel : 06.105.704.0
POTAIN U.K.	Great Britain	Tel : 0895.44.52.61
Simma POTAIN	Italia	Tel : 02.97.96.71
POTAIN Portugal	Portugal	Tel : 02.968.08.89

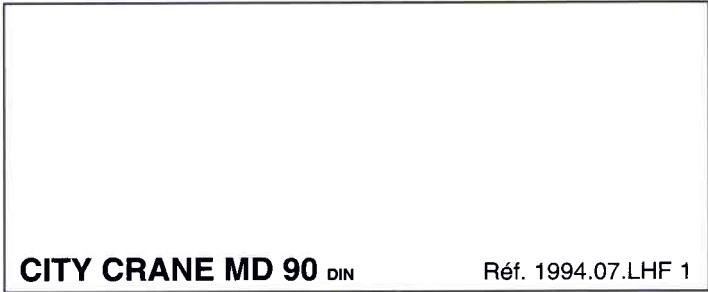

**CITY CRANE MD 90** DIN

Réf. 1994.07.LHF 1