

# Potain MCT 50

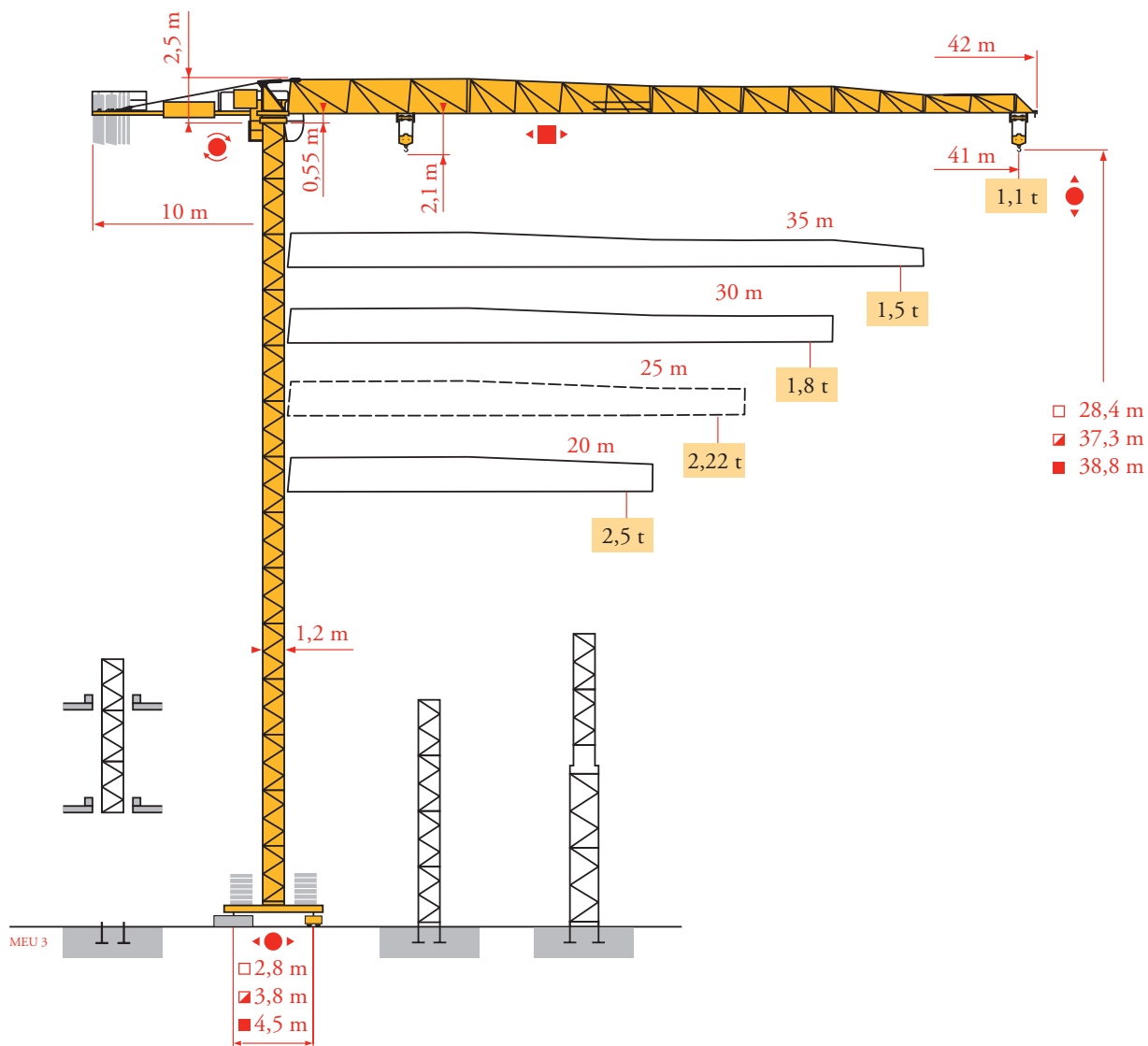

Mat / Réactions  
 Maste / Eckdrücke  
 Masts / Reactions  
 Mástil / Reacciones  
 Torre / Reazioni  
 Tramo / Reações  
 Композиции башни /  
 Реакции

MEU 4

1,2 m  
 20 m ⇒ 41 m

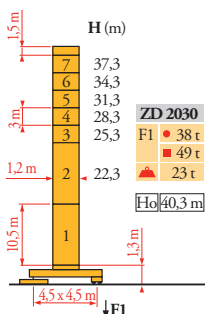
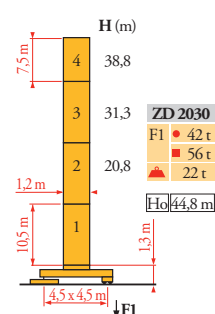
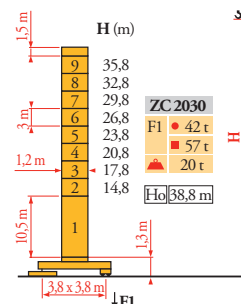
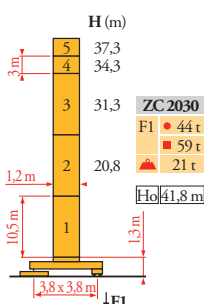
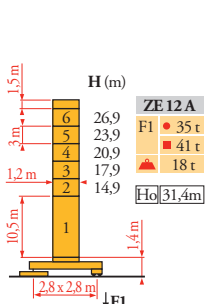
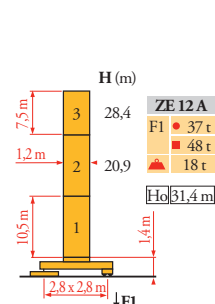
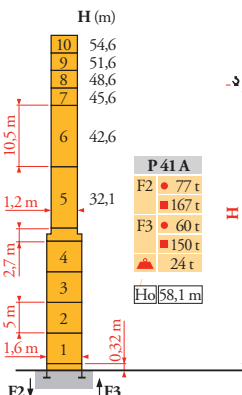
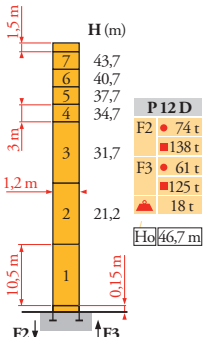
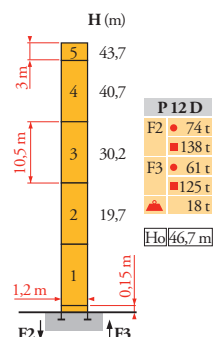
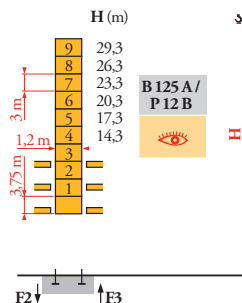
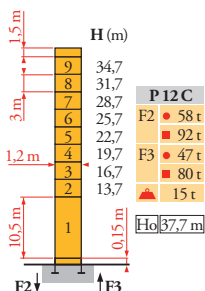
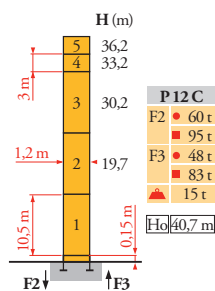

	ZE 12 A	ZC 2030 ZD 2030
2	 H <sub>2</sub> = H + 0,15 m	H <sub>2</sub> = H + 0,3 m
3	 H <sub>3</sub> = H	H <sub>3</sub> = H
4	 H <sub>4</sub> = H	H <sub>4</sub> = H + 0,2 m

- FR** ● Réactions en service    ● Reaktionskräfte in Betrieb    ● Reactions in service    ● Reacciones en servicio    ● Reazioni in servizio    ● Reações em serviço    ● Реакции при работе
- Réactions hors service    ■ Reaktionskräfte außer Betrieb    ■ Reactions out of service    ■ Reacciones fuera de servicio    ■ Reazioni fuori servizio    ■ Reações fora de serviço    ■ Реакции в покое
- A vide sans lest (ni train de transport) avec flèche et hauteur maximum    Ohne Last, Ballast (und Transportachse), mit Maximalausleger und Maximalhöhe    Without load, ballast (or transport axes), with maximum jib and maximum height    Sin carga, sin lastre, (ni tren de transporte), flecha y altura máxima    A vuoto, senza zavorra (ne assali di trasporto) con bracci massimo e altezza massima    Sem carga (nem trem de transporte)- sem lastro com lança e altura máximas    Вес без груза, балласта (или транспортных осей), с максимальной длиной стрелы и максимальной высотой
- Ho** H sans cabine    H Ohne Fahrerhaus    H without cab    H sin cabina    H senza cabina    H sem cabine    Высота без кабины

Courbes de charges  
Lastkurven  
Load diagrams  
Curvas de cargas  
Curve di carico  
Curva de cargas  
Диаграммы  
грузоподъемностей

MEU3

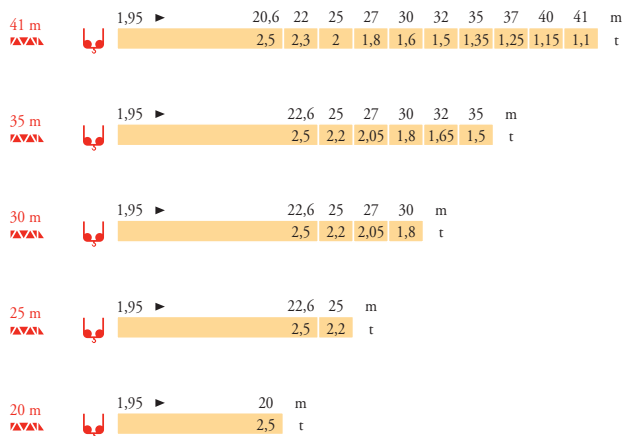

Télescopage sur dalles  
Kletterkrane im Gebäude  
Climbing crane  
Telescopage gruas  
trepadoras  
Gru in cavedio  
Telescopagem sobre  
lages  
Кран, ползущий внутри  
здания

MEU4

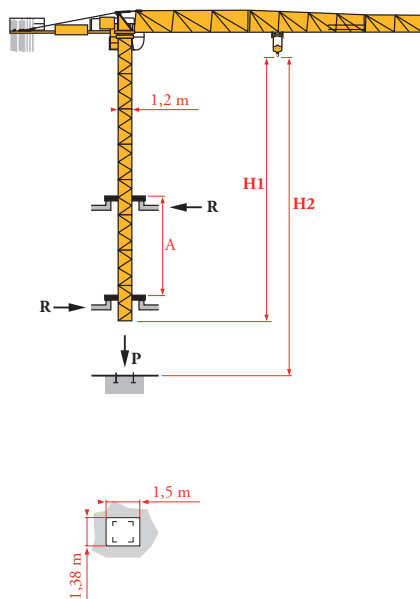



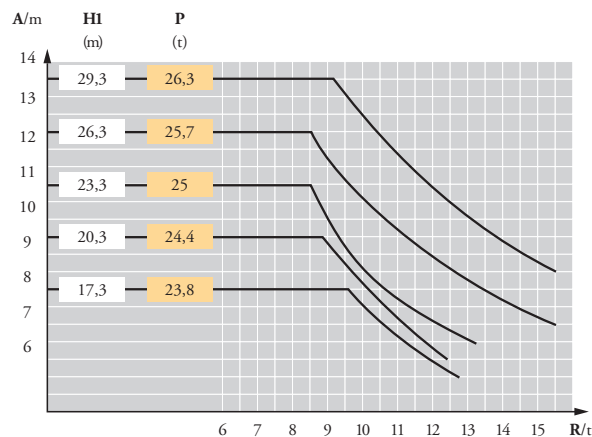







B 125 A



	FR	DE	EN	ES	IT	PT	RU
<b>A</b>	Distance entre cadres	Abstand zwischen den Rahmen	Distance between collars	Distancia entra marcos	Distanza fra i telai	Distância entre quadros	Расстояние между рамками крепления
<b>H1</b>	Hauteur grue	Kranhöhe	Crane height	Altura grúa	Altezza gru	Altura da grua	Высота крана
<b>P</b>	Poids de la grue(en service)	Krangewicht (in Betrieb)	Crane weight (in service)	Peso de la grúa (en servicio)	Peso della gru (in servizio)	Peso da grua (em serviço)	Вес крана (при работе)
<b>R</b>	Réaction horizontale	Horizontalkräfte	Horizontal reaction	Reaccion horizontal	Reazione orizzontale	Reacção horizontal	Горизонтальные реакции
	Voir télescopage sur dalles	Siehe Kletterkrane im Gebäude	See climbing crane	Veá grua trepadora	Consultare gru in cavedio	Ver telescopagem sobre lages	См. кран, ползущий внутри здания

Mécanismes  
Antriebe  
Mechanisms  
Mecanismos  
Meccanismi  
Mecanismos  
Механизмы

MEU 3

								ch - PS hp	kW							
	<b>15 LVF 13 Optima</b>	m/min	2,8	→	7,6	→	24	→	42	→	56	15	11	200 m		
		t	2,5		2,5		2,5		1,4		0,8					
	<b>25 LVF 13 Optima</b>	m/min	4,3	→	11,4	→	36	→	57	→	71	→	86	25	18	225 m
		t	2,5		2,5		2,5		1,45		1,1		0,62			
	<b>RVF 51 Optima +</b>	tr/min U/min - rpm	0 → 0,8						5,5	4						
	<b>2 DVF 2</b>	m/min	0 → 51						2	1,5						
	<b>ZE 12 A</b> 	<b>TVD 324</b>	m/min	26						2 x 4	2 x 2,9					
	<b>ZC 2030</b> <b>ZD 2030</b> 	<b>RT 224</b>	m/min	25						2 x 4	2 x 2,9					
		<b>CEI 38</b> 	<b>IEC 38</b>						<b>kVA</b>							
		400 V (+6% -10%) 50 Hz						15 LVF : 25 kVA 25 LVF : 35 kVA								

15 LVF 13 Optima

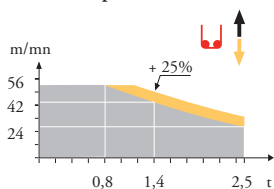

25 LVF 13 Optima

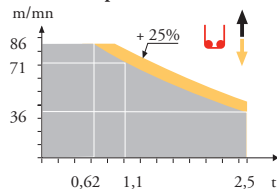

**FR**

Levage  
Distribution  
Orientation  
Translation

**DE**

Heben  
Katzfahren  
Schwenken  
Kranfahren

**EN**

Hoisting  
Trolleying  
Slewing  
Travelling

**ES**

Elevación  
Distribución  
Orientación  
Traslación

**IT**

Sollevamento  
Distribuzione  
Rotazione  
Traslazione

**PT**

Elevação  
Distribuição  
Rotação  
Translação

**RU**

Подъем  
Перемещение каретки  
Поворот  
Перемещение крана



Document commercial non contractuel. Pour toute information technique se référer à la notice correspondante.

Unverbindliches Vertriebsdokument. Für technische Informationen, siehe die entsprechenden Anweisungen.

This commercial document is not legally binding. For any technical information, please refer to the corresponding instructions.

Documento comercial no contractual. Para cualquier información técnica, ver la noticia correspondiente.

Documento commerciale non vincolante, per tutte le informazioni tecniche fare riferimento al catalogo istruzioni.

Documento comercial não contractual. Para qualquer informação técnica complementar consultar as respectivas instruções.

Этот коммерческий документ не является юридически обязательным. Для получения технической информации, см. соответствующие инструкции.



**Manitowoc - Americas - World Headquarters**  
2400 S. 44th Street • Manitowoc • WI 54220 USA  
Tel: +1 920 684 4410 • Fax: +1 920 652 9778

**Manitowoc - Europe, Middle East & Africa**  
Manitowoc France SAS  
18, rue de Charbonnières B.P. 173 • 69132 ECULLY Cedex • FRANCE  
Tel: +33 (0)4 72 18 20 20 • Fax: +33 (0)4 72 18 20 00

**Manitowoc - Asia Pacific**  
16F Xu Hui Yuan Building,  
1089 Zhongshan No.2 Road (S) • Shanghai 200030 China  
Tel: +86 21 6457 0066 • Fax: +86 21 6457 4955