

POTAIN

MC 78

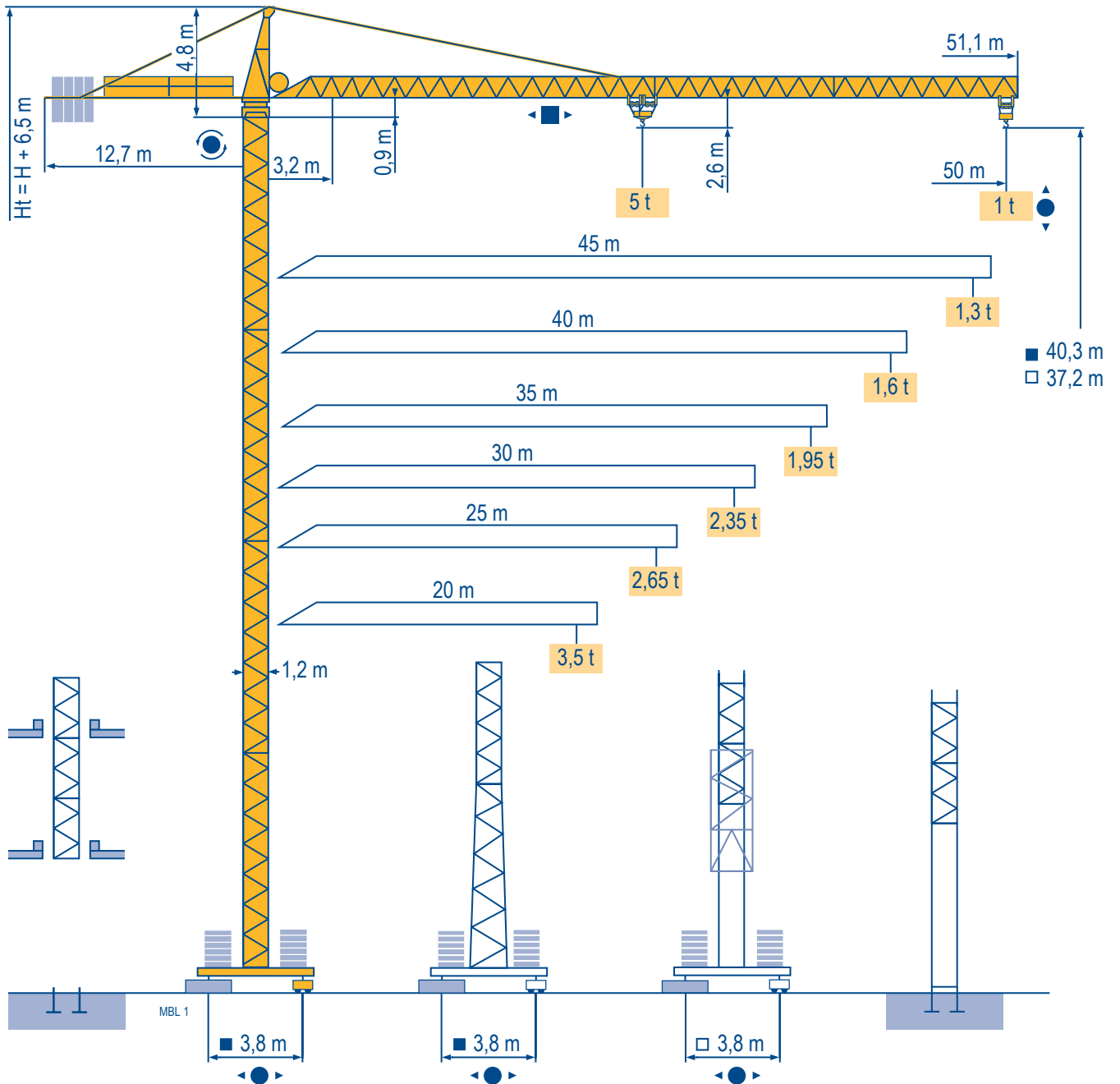

CITY CRANE

 FEM 1.001-A3

Mat / Réactions \square 1,2 m

Maste /
Eckdrücke
Masts /
Reactions
Mástil /
Reacciones
Torre / Reazioni
Tramo /
Reacções

MBL 2

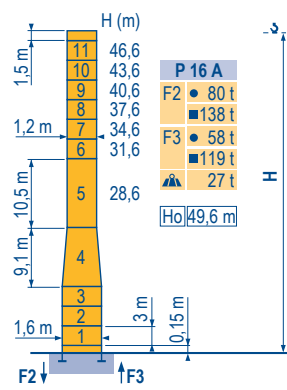
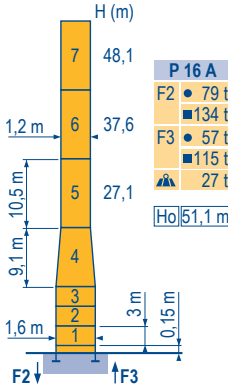
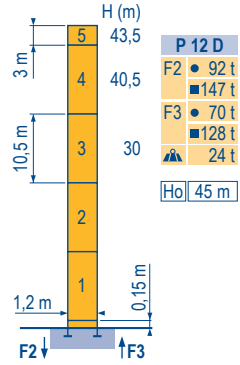
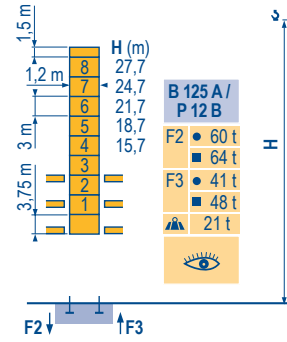
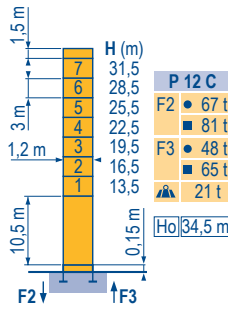
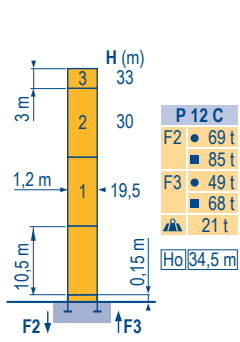

\square 1,2 m
20 m \Rightarrow 50 m

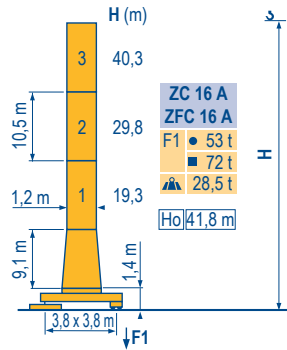
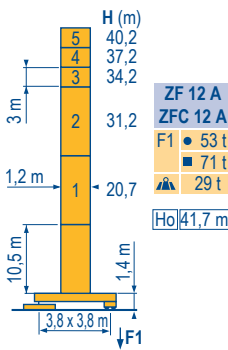
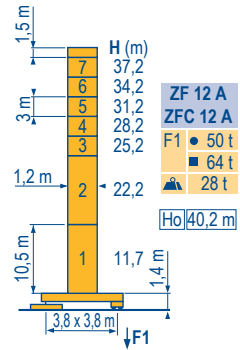

ZF - ZC - ZFC

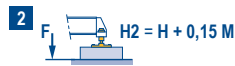

CITY CRANE
MC 78



F	D	GB	E	I	P
● Réactions en service	● Reaktionskräfte in Betrieb	● Reactions in service	● Reacciones en servicio	● Reazioni in servizio	● Reacções em serviço
■ Réactions hors service	■ Reaktionskräfte außer Betrieb	■ Reactions out of service	■ Reacciones fuera de servicio	■ Reazioni fuori servizio	■ Reacções fora de serviço
▲ A vide sans lest (ni train de transport) avec flèche et hauteur maximum.	▲ Ohne Last, Ballast (und Transportachse), mit Maximalausleger und Maximalhöhe.	▲ Without load, ballast (or transport axles), with maximum jib and maximum height.	▲ Sin carga, sin lastre, (ni tren de transporte), flecha y altura máxima.	▲ A vuoto, senza zavorra (ne assali di trasporto) con braccio massimo e altezza massima.	▲ Sem carga (nem trem de transporte)- sem lastro com lança e altura máximas.
Ho H sans cabine	Ho H Ohne Fahrerhaus	Ho H without cab	Ho H sin cabina	Ho H senza cabina	Ho H sem cabine

Courbes de charges

Lastkurven

Load diagrams

Curvas de cargas

Curve di carico

Curva de cargas

MBL 1

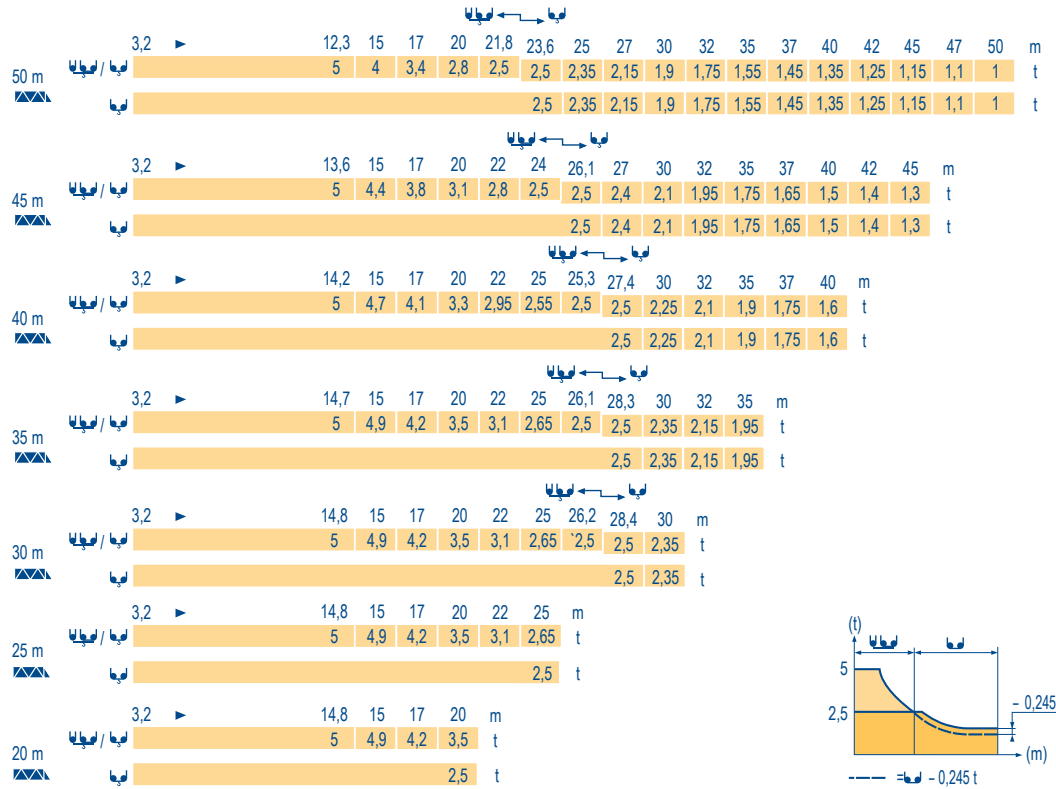

Télescopage sur dalles
Kletterkrane im Gebäude
Climbing crane
Telescopage gruas trepadoras
Gru in cavedio
Telescopagem sobre lages

MBL 1

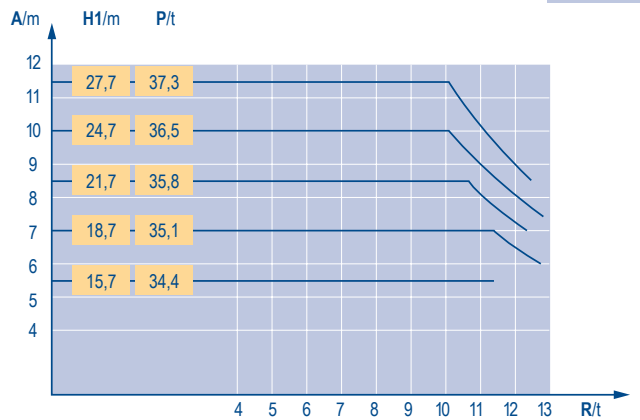
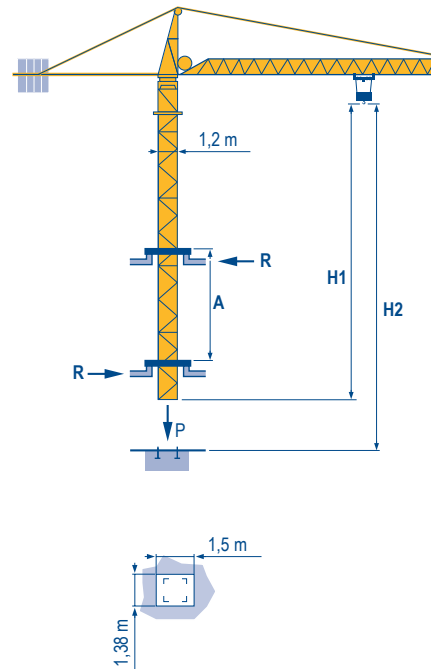

CITY CRANE
MC 78



	F	D	GB	E	I	P
A	Distance entre cadres	Abstand zwischen den Rahmen	Distance between collars	Distancia entra marcos	Distanza fra i telai	Distância entre quadros
H1	Hauteur grue	Kranhöhe	Crane height	Altura grúa	Altezza gru	Altura da grua
P	Poids de la grue(en service)	Krangewicht (in Betrieb)	Crane weight (in service)	Peso de la grúa (en servicio)	Peso della gru (in servizio)	Peso da grua (em serviço)
R	Réaction horizontale	Horizontalkräfte	Horizontal reaction	Reaccion horizontal	Reazione orizzontale	Reacção horizontal
	Voir télescopage sur dalles	Siehe Kletterkrane im Gebäude	See climbing crane	Veja grua trepadora	Consultare gru in cavedio	Ver telescopagem sobre lages

Mécanismes
Antriebe
Mechanisms
Meccanismi
Mecanismos

MBL 2

			U			UU			ch - PS hp	kW	
	15 PC 13-6	m/min	7,2	21,5	43	3,6	11	21,5	15	11	185 m
		t	2,5	2,5	1,3	5	5	2,6			
	25 PC 13-8	m/min	8,2	33	66	4,1	16,5	33	25	18	323 m
		t	2,5	2,5	1,3	5	5	2,6			
	20 LVF 13	m/min	5 → 28,4 → 52,6 → 69			2,5 → 14,4 → 26,3 → 34,5			20	15	323 m
		t	2,5	2,5	1,3	0,65	5	5			
	4 D3 V3	m/min	15 - 30 - 58						4	3	
	RVCV 60	tr/min U/min rpm	0 → 0,8						8	6	
	TVD 324	m/min	26						2 x 4	2 x 2,9	
	RT 224	m/min	25						2 x 4	2 x 2,9	
CEI 38			IEC 38			kVA					
400 V (+6% -10%) 50 Hz						15 PC : 30 kVA 25 PC : 35 kVA 20 LVF : 30 kVA					

F	D	GB	E	I	P
Levage	Heben	Hoisting	Elevación	Sollevamento	Elevação
Distribution	Katzfahren	Trolleying	Distribución	Distribuzione	Distribuição
Orientation	Schwenken	Slewing	Orientación	Rotazione	Rotação
Translation	Kranfahren	Travelling	Traslación	Traslazione	Translação

Document commercial non contractuel. Pour toute information technique se référer à la notice correspondante. Unverbindliches Vertriebsdokument. Für technische Informationen, siehe die entsprechenden Anweisungen. This commercial document is not legally binding. For any technical information, please refer to the corresponding instructions. Documento comercial non contractuel. Para cualquier información técnica, ver la noticia correspondiente. Documento commerciale non vincolante, per tutte le informazioni tecniche fare riferimento al catalogo istruzioni. Documento comercial não contratual. Para qualquer informação técnica complementar consultar as respectivas instruções.



Americas
Tel : +1 888 479 7278
Tel : +1 717 593 2000

Europe – Middle East – Africa
Tel : +33 (0) 4 72 81 50 00
Tel : +44 (0) 191 522 2000

Asia – Pacific
Tel : +65 6264 1188
Fax : +65 6862 4142

www.manitowoccrane.com

18, rue de Charbonnières - B.R.173
69132 ECULLY Cedex - France
Tél. : +33 (0) 4 72 18 20 20
Fax. : +33 (0) 4 72 18 20 00
www.manitowoccrane.com

CITY CRANE MC 78
Réf. 2004 39 MBL 3

Copyright.Reproduction interdite © POTAIN 2004

Réalisation Secotec