

TOPKIT MC 180

LJA 1

POTAIN 



Mats - Maste - Masts
Mástil - Torre - 塔身



□ 1,6m

Fèche - Ausleger - Jib
Flecha - Braccio - 起重臂
40m → 55m

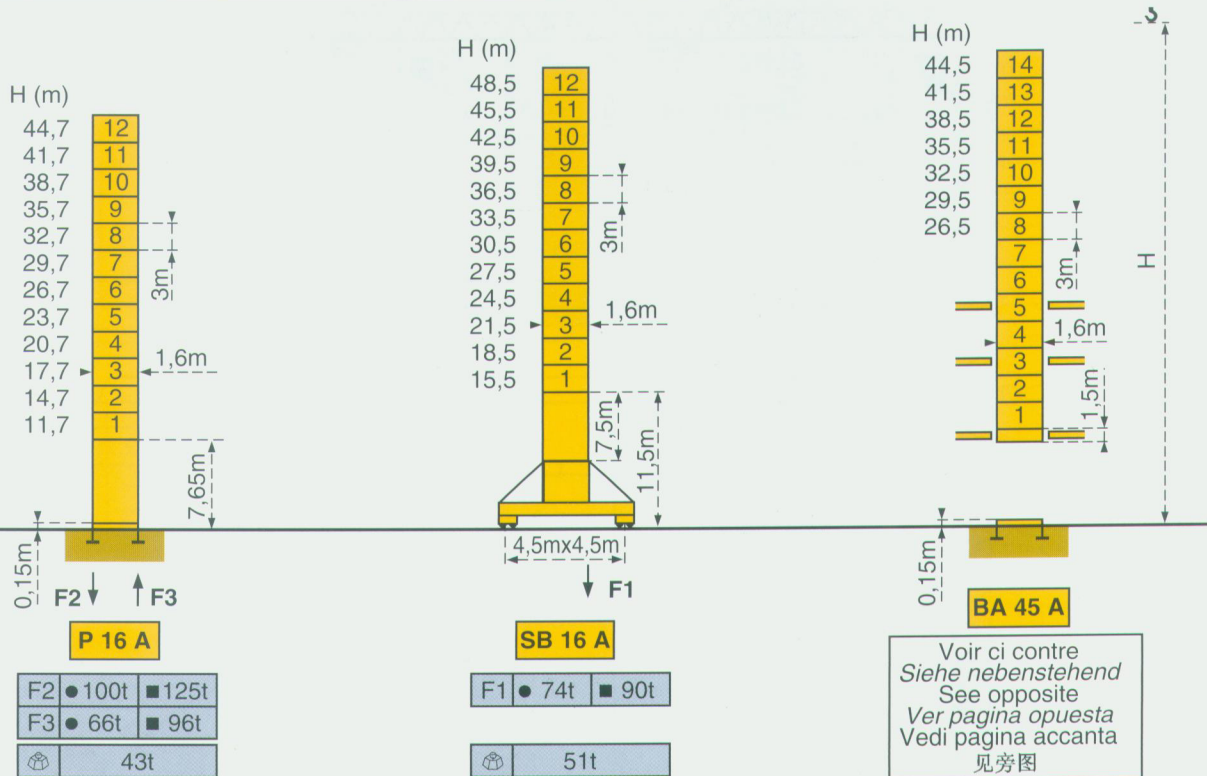

Voir ci contre
Siehe nebenstehend
See opposite
Ver pagina opuesta
Vedi pagina accanto
见旁图

Mats - Maste - Masts
Mástil - Torre - 塔身



□ 2m

Fèche - Ausleger - Jib
Flecha - Braccio - 起重臂
40m → 60m

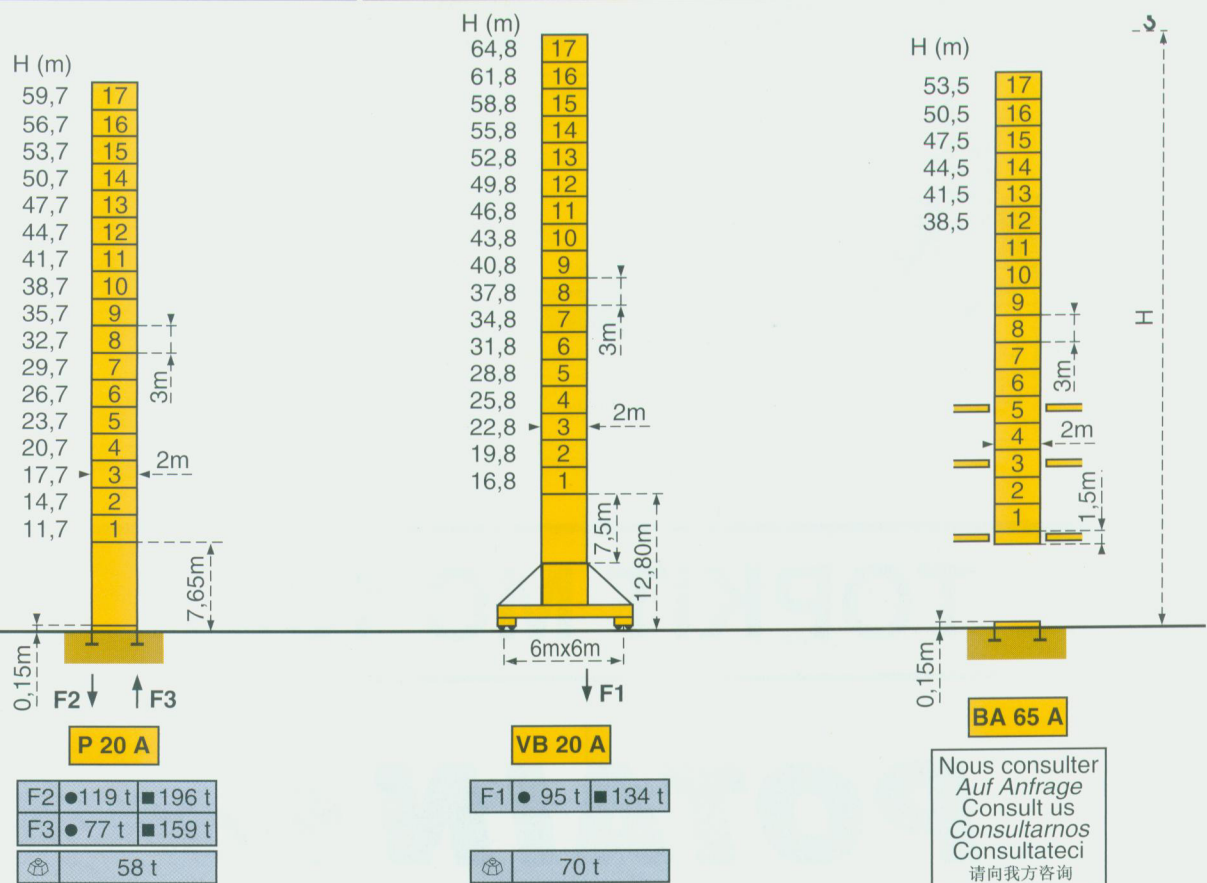

Nous consulter
Auf Anfrage
Consult us
Consultarnos
Consultateci
请向我方咨询

Flèche
Ausleger
Jib
Flecha
Braccio
起重臂

Courbes de charges - Lastkurven - Load diagrams Curvas de cargas - Curve di carico - 负荷曲线

MC 180 8 T

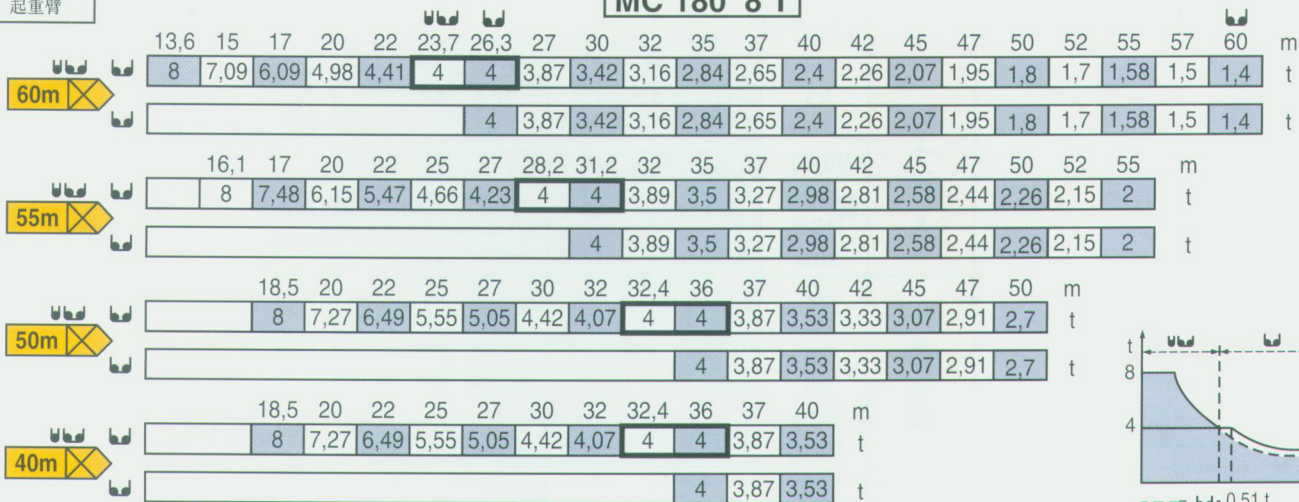

MC 180 10 T

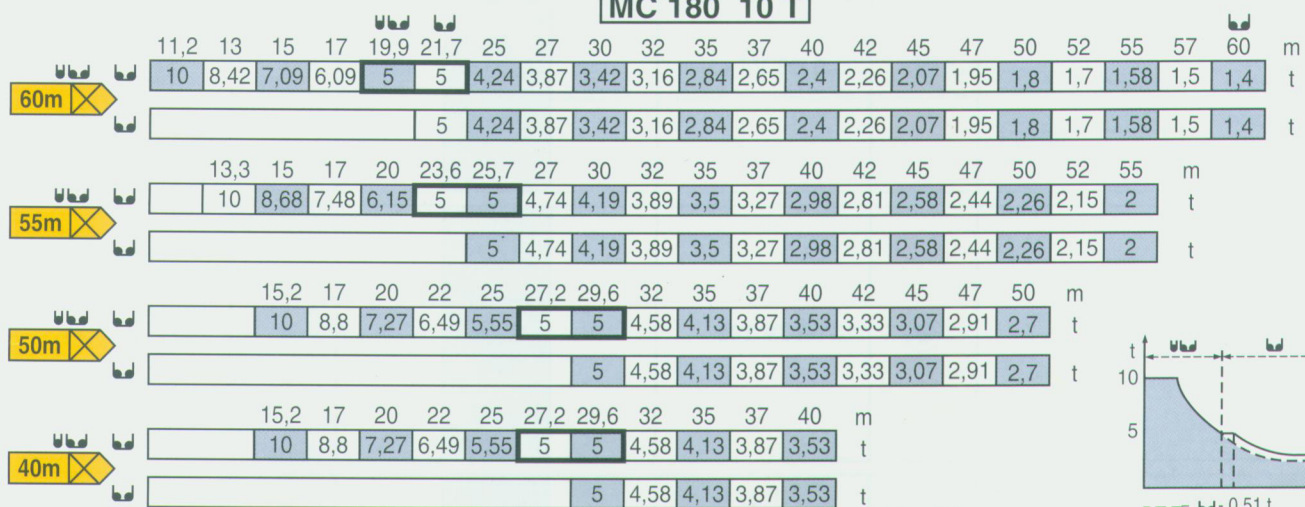

Télescopage sur dalles - Kletterkrane im Gebäude - Climbing crane Telescopage gruas trepadoras - Gru in cavedio - 楼板上顶升

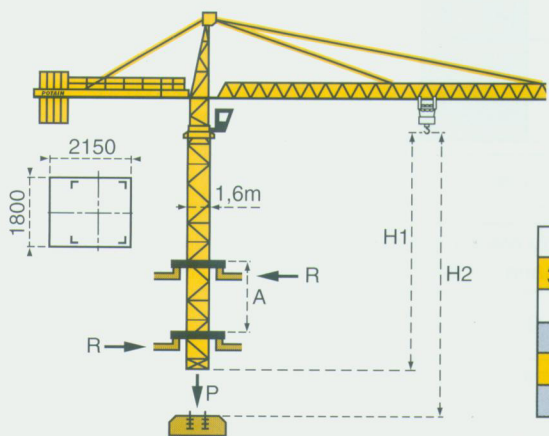

Mât de 2m : nous consulter
Mast von 2m : Auf Anfrage
2 m mast : consult us
Mástil de 2m : consultamos
Torre 2m : consultateci
2米标准节: 请向我方咨询

H2			
33 PC 20 -1	55 RCS 20D		
90m	180m	141m	283m
33 PC 25	55 RCS 25/13		
90m	180m	140m	280m

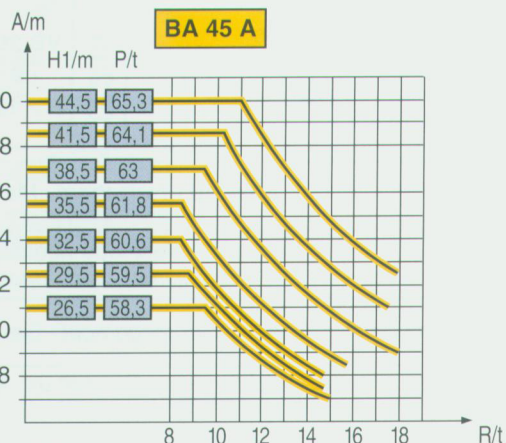

A Distance entre cadres
H1 Hauteur grue
P Poids de la grue (en service)
R Réaction horizontale

A Abstand zwischen den Rahmen
H1 Kranhöhe
P Krangewicht (in Betrieb)
R Horizontalkräfte

A Distance between collars
H1 Crane height
P Crane weight (in service)
R Horizontal reaction

A Distancia entre marcos
H1 Altura grúa
P Peso de la grúa (en servicio)
R Reaccion horizontal

A Distanza fra i telai
H1 Altezza gru
P Peso della gru (in servizio)
R Reazione orizzontale

A 各附着框之间距离
H1 工作状态下塔机高度

P 工作状态下塔机重量
R 水平反力

● En service
■ Hors service

● In Betrieb
■ Ausser Betrieb

● In service
■ Out of service

● En servicio
■ Fuera de servicio

● In servizio
■ Fuori servizio

● 工作状态
■ 非工作状态

⊗ A vide sans lest avec flèche et hauteur maximum.

⊗ Ohne Last und Ballast mit Maximalausleger und Maximalhöhe.











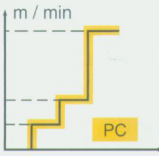



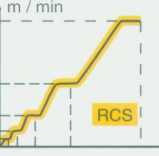

⊗ Without load and ballast with longest jib and maximum height.

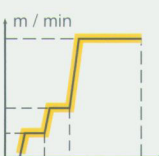
⊗ Sin carga, sin lastre con flecha y altura máxima.

⊗ A vuoto senza zavorra e con braccio massimo e altezza massima.

⊗ 空载, 无配重, 起重臂和高度均为最大值

Mécanismes - Antriebe - Mechanisms - Mecanismos - Meccanismi - 机构

			m/min	t	m/min	t		ch -PS hp	kW	
Levage Heben Hoisting Elevación Sollevamento 起升	 PC	 8t					360m >360m*	33	24	
			33 PC	4,6	4	2,3				8
			20 - 1	28	4	14				8
				56	2	28				4
	 RCS	 10t					566m >566m*	55	40,5	
			55 RCS	0→52	4	0→26				8
			20D	0→104	2	0→52				4
Distribution Katzfahren Trolleying Distribución Ditribuzione 变幅			5 D3 V4 - 1		15-30-58			5	3,7	
Orientation Schwenken Slewing Orientación Rotazione 回转			RCV 145		0→0,8 tr/min rpm			2x6	2x4,4	
Translation Kranfahren Travelling Traslación Traslazione 行走	1,6 m 	SB 16A  R ≥ 10m	RT 324		12,5 - 25		2x7	2x5,2		
			TCV 449 ARC H ≤ 35,2m		10 - 50		4x6,8	4x5		
	2 m 	VB 20A  R ≥ 13m	RT 544 A1 2V		13,5 - 27		4x7	4x5,2		
			TCV 649 ARC H ≤ 43,4m		10 - 50		4x6,8	4x5		
Réseau - Netzstrom - Mains supply - Red - Rete elettrica - 电网							CEI 38 IEC 38	400V(+6%-10%) 50 Hz		
Puissance électrique nécessaire - Anschlusswert - Necessary electric power Potencia eléctrica necesaria - Potenza elettrica necessaria - 所需功率								33 PC : 50 KVA 55 RCS : 80 KVA		
Groupe électrogène - Stromaggregat - Generator set - Grupo electrogeno - Gruppo elettrogeno - 发电机组								*		

*Nous consulter - Auf Anfrage - Consult us - Consultarnos - Consultateci - 请向我方咨询

Conforme aux directives CEE 84/534 et 87/405 sur le niveau acoustique - Gemäss EWG-Richtlinien 84/534 und 87/405 für den Schall- Leistungspegel
 In compliance with the EEC 84/534 and 87/405 Instructions on noise level - Conforme con las directivas CEE 84/534 y 87/405 sobre el nivel acustico
 Conforme alle direttive CEE 84/534 e 87/405 sul livello acustico - 符合 CEE 84/534 - CEE 87/405 声响应度规定



Copyright.Reproduction interdite © POTAIN 1995

POTAIN 

GRUPE LEGRIS INDUSTRIES

18.Rue de Charbonnières, B.P. 173-F 69132 ECULLY Cedex
 Tél. (33)04.72.20.20.20 - Fax (33)04.72.20.20.00
 http://www.potain.fr - E-mail : mkt@potain.fr

POTAIN GmbH Deutschland Tel : 06.105.704.0
 SIMMAPOTAIN Italia Tel : 039.65.631
 Zhangjiagang POTAIN China Tel : 520.877.1451

TOPKIT MC 180

Réf. 1995.24 LJA 2