

Potain MC 115 B

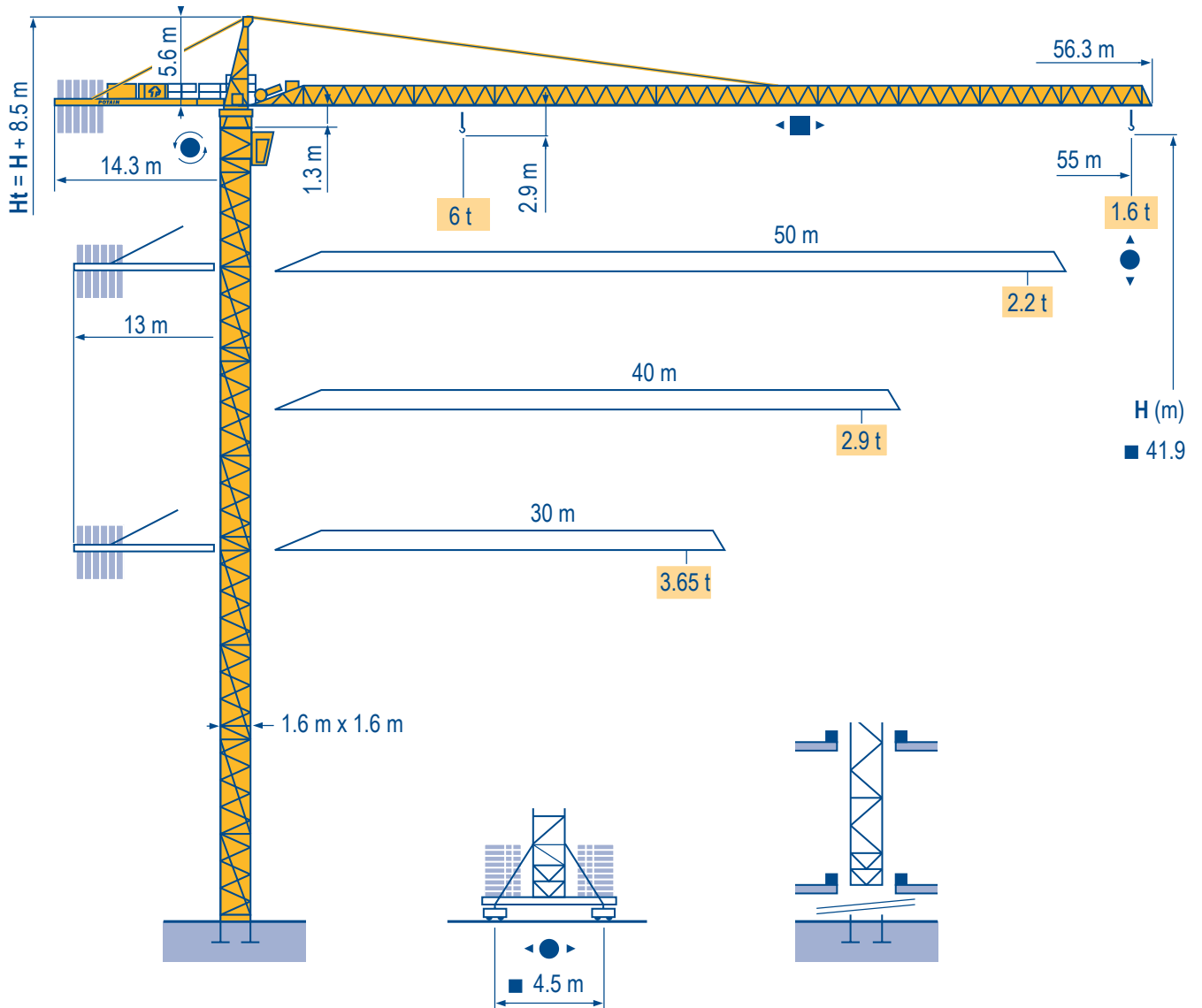

Masts / Reactions
 Композиции башни / Реакции

□ 1,6 m



30 m → 55 m

MBX 4

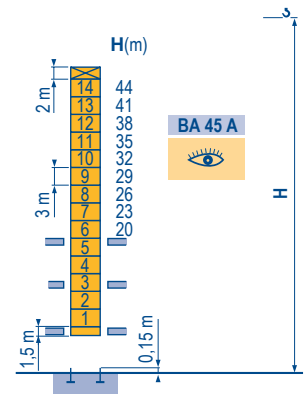
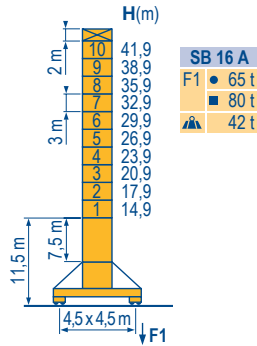
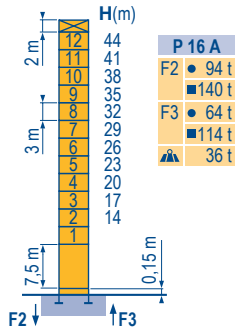

Climbing crane
 Кран, ползущий внутри здания

MBX 3

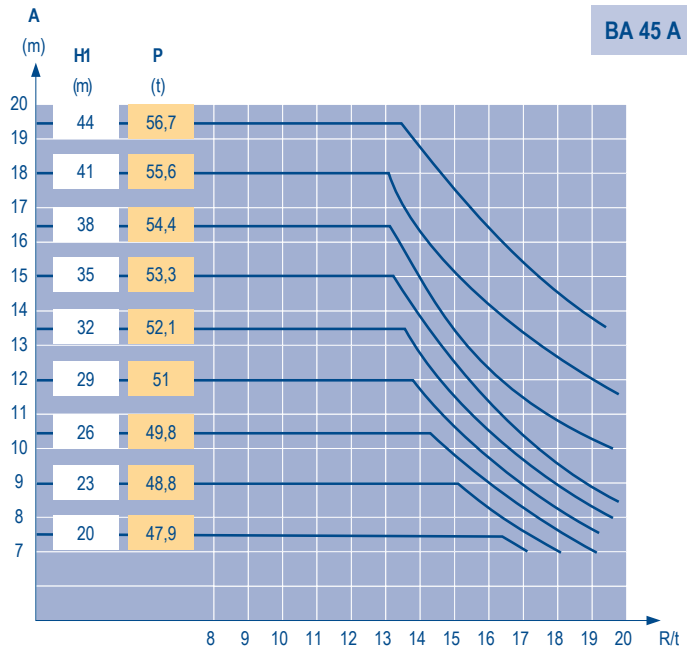
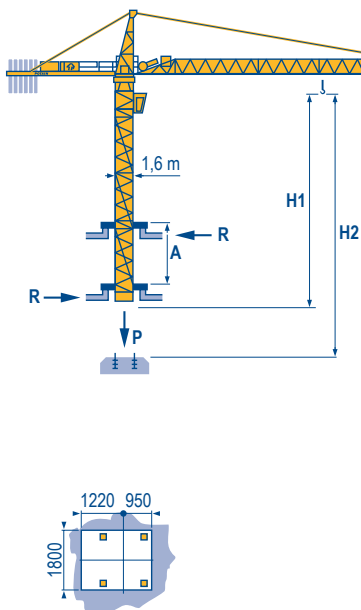

CITY CRANE
 MC 115 B

Potain

EN

- Reactions in service
- Reactions out of service
- ▲ Without load, ballast (or transport axles), with maximum jib and maximum height.
- 👁 See climbing crane

RU

- Реакции при работе
- Реакции в покое
- Вес без груза, балласта (или транспортных осей), с максимальной длиной стрелы и максимальной высотой.
- См. кран, ползущий внутри здания

Load diagrams
Диаграммы грузоподъемностей

MBX 2

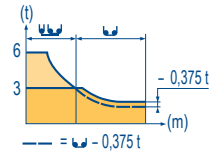
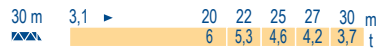
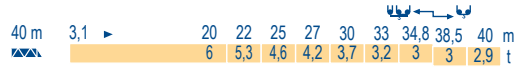
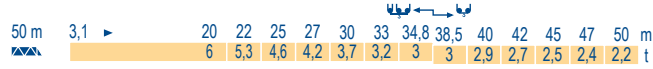
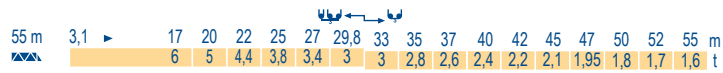

Counter-jib ballast
Балласт на консоли

MBX 3

			3450 kg	2250 kg	(kg)
55 m	14,3 m	4	1	16 050	
50 m	13 m	4	1	16 050	
40 m	13 m	4	-	13 800	
30 m	13 m	2	2	11 400	

Base ballast
Базовый балласт

MBX 3

	SB 16 A -	H (m)	41,9	38,9	35,9	32,9	29,9	26,9	23,9	20,9	17,9	14,9
		(t)	84	72	60	42	42	42	42	42	42	42

Anchorage
Рамки для крепления к зданию

P 16 A

MBX 2

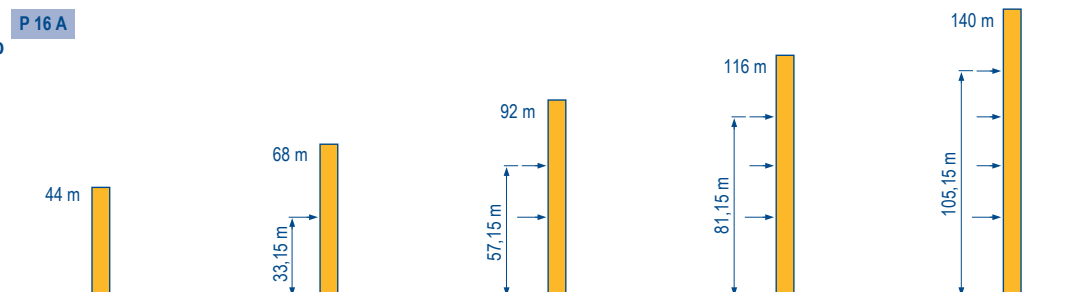

CITY CRANE
MC 115 B

Potain

EN

















- A Distance between collars
- H1 Crane height
- P Crane weight (in service)
- R Horizontal reaction

RU

- Расстояние между рамками крепления
- Высота крана
- Вес крана (при работе)
- Горизонтальные реакции

Mechanisms
Механизмы

MBX 5

								hp	kW		
											
	33 PC 15	m/min	6,2	38	76	3,1	19	38	33	24	260 m
		t	3	3	1,5	6	6	3			
	45 RCS 15 GH	m/min	0 → 56		0 → 112	0 → 28		0 → 56	45	33	408 m
		t	3		1,5	6		3			
	4 D3 V3	m/min	15 - 30 - 58						4	3	
	RCV 145	rpm	0 → 0,8						2 x 6	2 x 4,4	
	SB 16 A RT 324 R ≥ 10 m	m/min	12,5 → 25						2 x 7	2 x 5,2	
		CEI 38		IEC 38							
		400 V (+6% -10%) 50 Hz				33 PC : 50 kVA 45 RCS : 65 kVA					

EN

-  Hoisting
-  Trolleying
-  Slewing
-  Travelling

RU

- Подъем
- Перемещение каретки
- Поворот
- Перемещение крана



This commercial document is not legally binding.
For any technical information, please refer to the corresponding instructions.

Этот коммерческий документ не является юридически обязательным.
Для получения технической информации, см. соответствующие инструкции.

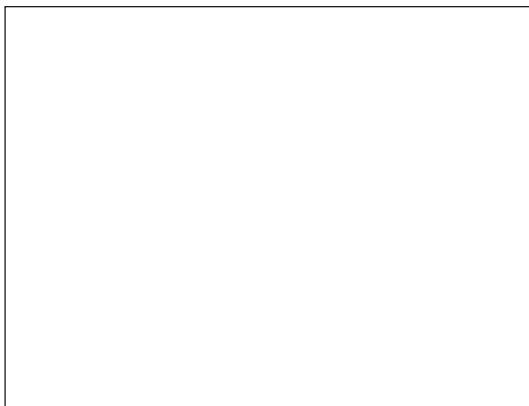

MC 115 B
Réf. 2009 45 MBX 7



Asia-Pacific Factories

China • No.55 East Zhen Bei Road, Zhangjiagang Economic Development Zone (South), Jiangsu Province, China 215618
Tel 86 512 58780 088 Fax 86 512 5878 0098

India • 72-76, Mundhwa Industrial Estate, Pune - 411 036, Maharashtra, India Tel 91 20 6644 5500 Fax 91 20 6644 5599

Regional Headquarters

Americas • Manitowoc, Wisconsin, USA • Tel 1 920 684 6621 Fax 1 920 683 6278

Europe, Middle East & Africa • Ecully, France • Tel 33 472 18 2020 Fax 33 472 18 2000

Asia Pacific • Shanghai, China • Tel 86 21 6457 0066 Fax 86 21 6457 4955