

Potain Igo 36

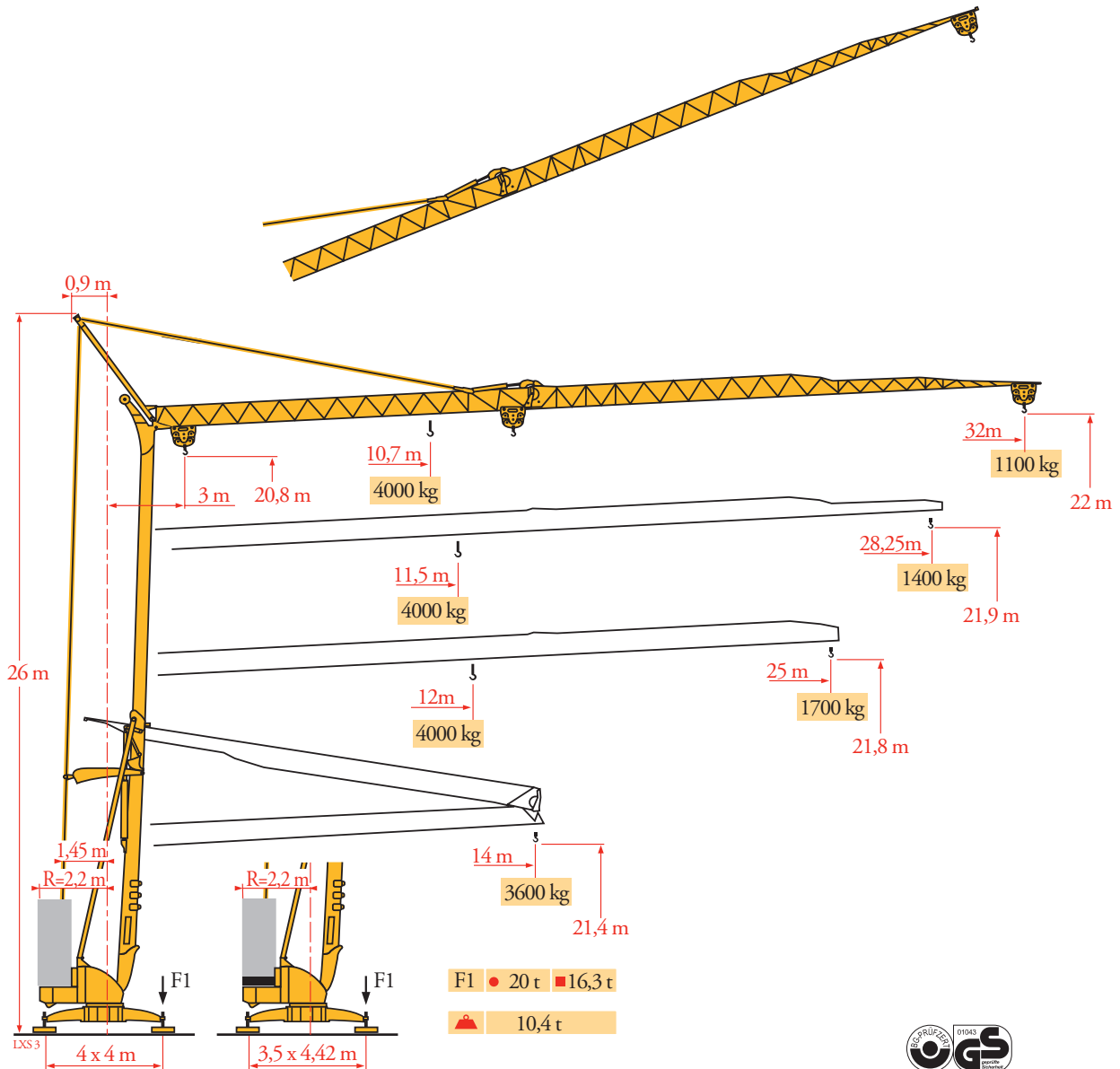

Courbes de charges
Lastkurven
Load diagrams
Curvas de cargas
Curve di carico
Curva de cargas
Диаграммы грузоподъемностей

LX5 3

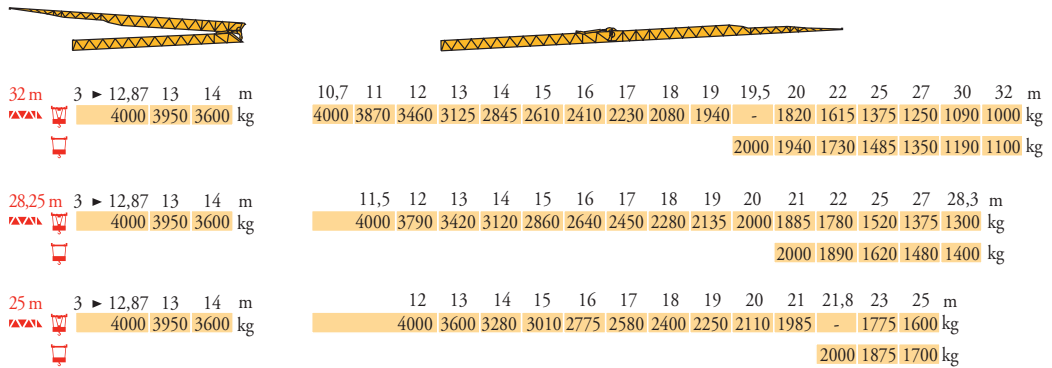

Flèche relevée
Ausleger in Steilstellung
Luffing jib
Flecha izada
Braccio impennato
Lança inclinada
Маховая стрела

LX5 3

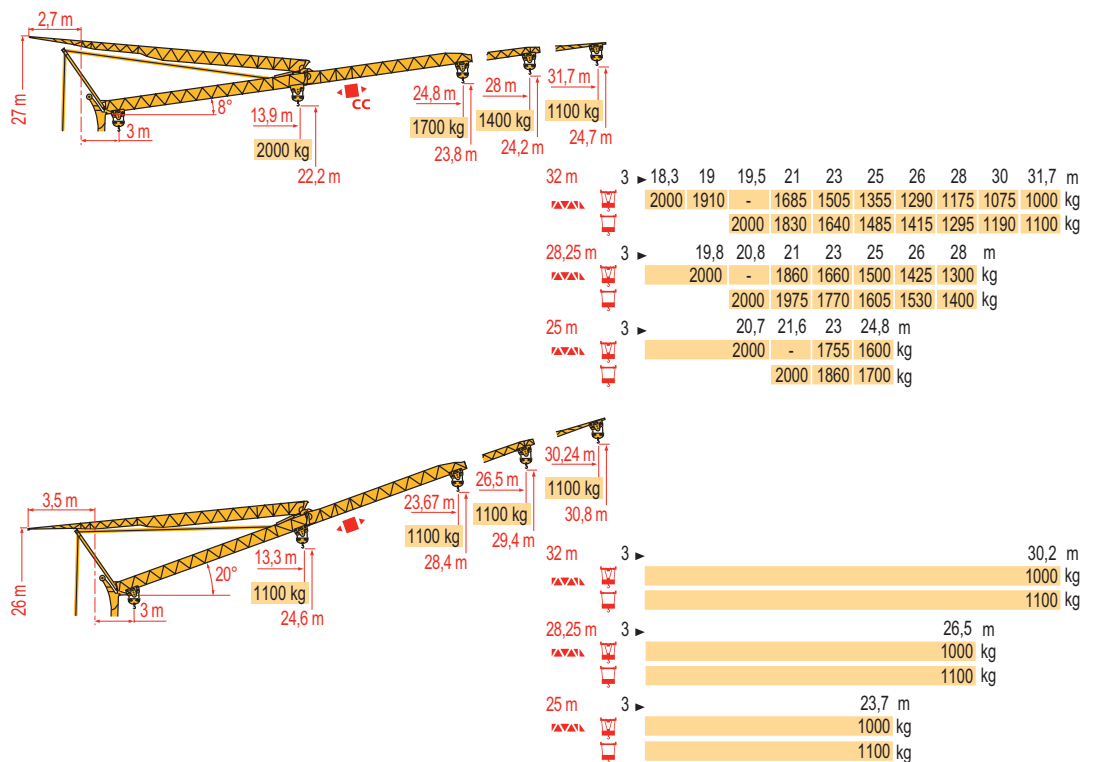

FR

Chariot distributeur
Chariot distributeur et courbes de charges
Réactions en service
Réactions hors service

A vide sans lest (ni train de transport) avec flèche et hauteur maximum

DE

Verfahrbare Laufkatze
Verfahrbare Laufkatze und Lastkurven
Reaktionskräfte in Betrieb
Reaktionskräfte außer Betrieb

Ohne Last, Ballast (und Transportachse), mit Maximalausleger und Maximalhöhe

EN

Traversing trolley
Traversing trolley and load diagrams
Reactions in service
Reactions out of service

Without load, ballast (or transport axes), with maximum jib and maximum height

ES

Carro distribuidor
Carro distribuidor y curvas de cargas
Reacciones en servicio
Reacciones fuera de servicio

Sin carga, sin lastre, (ni tren de transporte), flecha y altura máxima

IT

Carrellino distributore
Carrellino distributore e curve di carico
Reazioni in servizio
Reazioni fuori servizio

A vuoto, senza zavorra (ne assali di trasporto) con braccio massimo e altezza massima

PT

Carro distribuidor
Carro distribuidor e curva de cargas
Reações em serviço
Reações fora de serviço

Sem carga (nem trem de transporte) - sem lastro com lança e altura máximas





RU

Грузовая тележка
Грузовая тележка и диаграммы грузоподъемностей
Реакции при работе
Реакции в покое

Вес без груза, балласта (или транспортных осей), с максимальной длиной стрелы и максимальной высотой

Mécanismes
Antriebe
Mechanisms
Mecanismos
Meccanismi
Mecanismos
Механизмы

LX5

		LX5					LX5					ch - PS hp	kW	
	15 LVF 10 Optima	m/min	3,6	18	30	49	66						15	11
		kg	2000	2000	2000	1100	500							
		m/min	3,6	18	30	54	66	1,8	8,9	15	27	33		
		kg	2000	2000	2000	1000	500	4000	4000	4000	2000	1000		
	3 DVF5	m/min	19 - 41									3	2,2	
	RVF+41	tr/min U/min rpm	0 → 0,8									4	3	
		CEI 38			IEC 38									
		400 V (+6% -10%) 50 Hz					15 LVF 10 : 22 kVA							

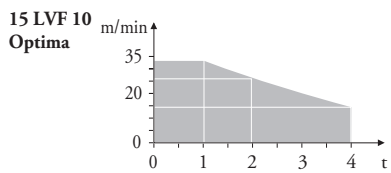

Montage
Montage
Erection
Montaje
Montaggio
Montagem
Монтаж

LX3

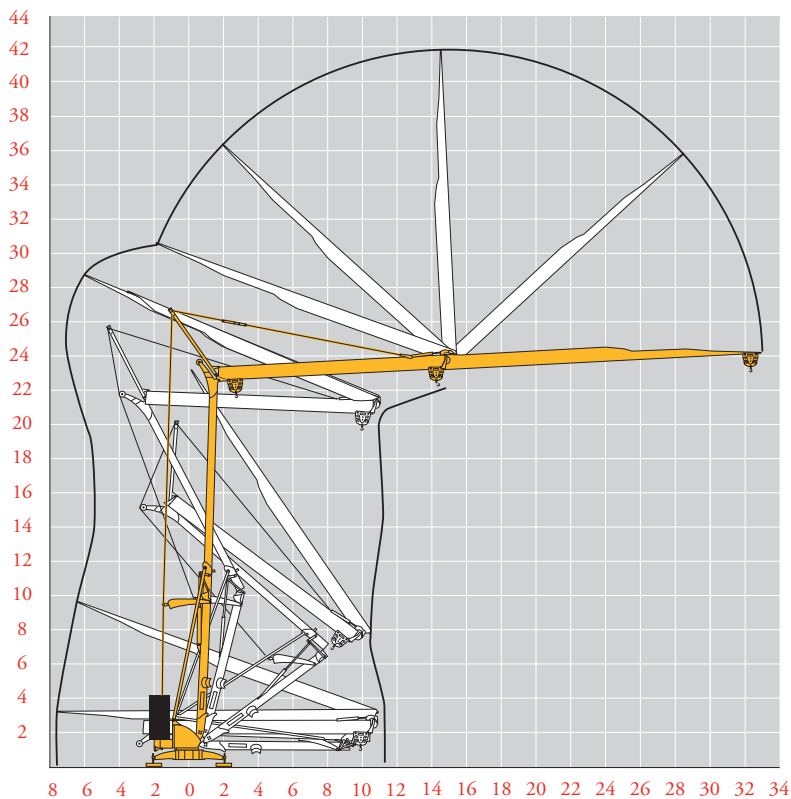

 **FR**
Levage
 Distribution
 Orientation

DE
Heben
Katzfahren
Schwenken

EN
Hoisting
Trolleying
Slewing

ES
Elevación
Distribución
Orientación

IT
Sollevamento
Distribuzione
Rotazione

PT
Elevação
Distribuição
Rotação

RU
Подъем
Перемещение каретки
Поворот

Transport
Transport
Transport
Transporte
Trasporto
Transporte
Транспортировка

LXS 4

		L (m)	B (m)	C (m)	D (m)	H (m)
DS61/S120	○					
DS61/S125	DS61/S120	15,9	2,45	3,73	7,08	3,05/3,2
DS61/S125	DS61/S125	15,9	2,45	3,73	7,08	3,05/3,2
DJ80/S120	○					
DJ80/S125	DJ80/S120	15,9	2,45	4,15	6,66	3,1
DJ80/S125	DJ80/S125	15,9	2,45	4,15	6,66	3,1
DJ100/S120	○					
DJ100/S125	DJ100/S120	16,33	2,45	4,15	6,66	3,23
DJ100/S125	DJ105/S125	16,33	2,45	4,15	6,66	3,23
DJ105/S125	DJ126M/S125	16,35	2,45	4,15	6,66	3,2
DJ105/S125	DJ126M/S215M	17,14	3,24	4,07	6,74	3,55
DJ126M/S125						
DJ126M/S215M						

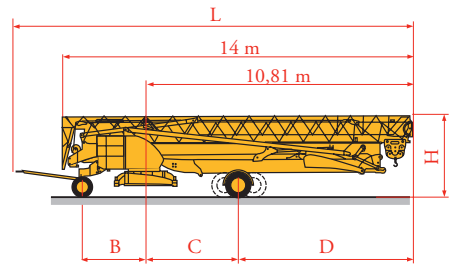

		C (m)	D (m)
SL122/J215M			
SL121/J135	SL122/J215M	4,07	6,74
SL121/J135	SL121/J135	4	6,66
SL121/S215M	SL121/S215M	4,07	6,74

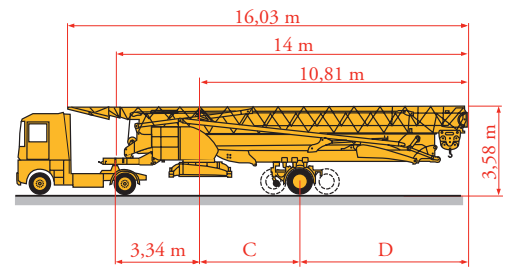

FR

○ Chantier

DE

Baustelle

EN

Site

ES

Obra

IT

Cantiere

PT

Estaleiro

RU

По строительной площадке



Document commercial non contractuel. Pour toute information technique se référer à la notice correspondante.

Unverbindliches Vertriebsdokument. Für technische Informationen, siehe die entsprechenden Anweisungen.

This commercial document is not legally binding. For any technical information, please refer to the corresponding instructions.

Documento commercial no contractual. Para cualquier información técnica, ver la noticia correspondiente.

Documento commerciale non vincolante, per tutte le informazioni tecniche fare riferimento al catalogo istruzioni.

Documento comercial não contratual. Para qualquer informação técnica complementar consultar as respectivas instruções.

Этот коммерческий документ не является юридически обязательным. Для получения технической информации, см. соответствующие инструкции.



Manitowoc - Americas - World Headquarters
2400 S. 44th Street • Manitowoc • WI 54220 USA
Tel: +1 920 684 4410 • Fax: +1 920 652 9778

Manitowoc - Europe, Middle East & Africa
Manitowoc France SAS
18, rue de Charbonnières B.P. 173 • 69132 ECULLY Cedex • FRANCE
Tel: +33 (0)4 72 18 20 20 • Fax: +33 (0)4 72 18 20 00

Manitowoc - Asia Pacific
16F Xu Hui Yuan Building,
1089 Zhongshan No.2 Road (S) • Shanghai 200030 China
Tel: +86 21 6457 0066 • Fax: +86 21 6457 4955

REF. 2003 48 LXS 7