

Courbes de charges
Lastkurven
Load diagrams
Curvas de cargas
Curve di carico
Curva de cargas

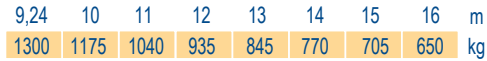

MBK 4

Flèche relevée
Ausleger in Steilstellung
Luffing jib
Flecha izada
Braccio impennato
Lança inclinada

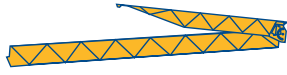
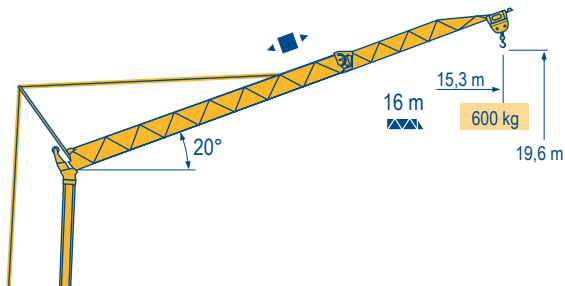

MBK 2

Igo 10

POTAIN



F
Chariot distributeur
Réactions en service
Réactions hors service
A vide sans lest (ni train de transport) avec flèche et hauteur maximum.

D
Verfahrbare Laufkatze
Reaktionskräfte in Betrieb
Reaktionskräfte außer Betrieb
Ohne Last, Ballast (und Transportachse), mit Maximalausleger und Maximalhöhe.

GB
Traversing trolley
Reactions in service
Reactions out of service
Without load, ballast (or transport axles), with maximum jib and maximum height.







E
Carro distribuidor
Reacciones en servicio
Reacciones fuera de servicio
Sin carga, sin lastre, (ni tren de transporte), flecha y altura máxima.

I
Carrellino distributore
Reazioni in servizio
Reazioni fuori servizio
A vuoto, senza zavorra (ne assali di trasporto) con braccio massimo e altezza massima.

P
Carro distribuidor
Reacções em serviço
Reacções fora de serviço
Sem carga (nem trem de transporte)- sem lastro com lança e altura máximas.

Mécanismes
Antriebe
Mechanisms
Mecanismos
Meccanismi
Mecanismos

MBK 4

									ch - PS hp	kW						
	6 LVF 7 Optima	230 V 	m/min	± 3,5	↑ 7	↓ 11,5	↑ 7	↓ 32	↑ 18	↓ 40	↑ 18	↓ 40	3,3	2,4		
		20 A 1	kg	1300	1300	1300	600	500								
		230 V 	m/min	± 3,5	↑ 11,5	↓ 11,5	↑ 17	↓ 32	↑ 27	↓ 40	↑ 27	↓ 40			5,2	3,8
		32 A 2	kg	1300	1300	1300	600	500								
		400 V 3	m/min	± 3,5	± 11,5	± 19	± 33	± 40	5,5	4						
			kg	1300	1300	1300	600	500								
	1 D1 V3	-	m/min	24							1,5	1,1				
	RVF 20	-	tr/min U/min rpm	0 → 1							1,5	1,1				
		CEI 38 	IEC 38								kVA					
		230 V(+6% -10%) 50 Hz 							230 V 20 A : 4,6 kVA 230 V 32 A : 7,4 kVA 400 V : 9,5 kVA							

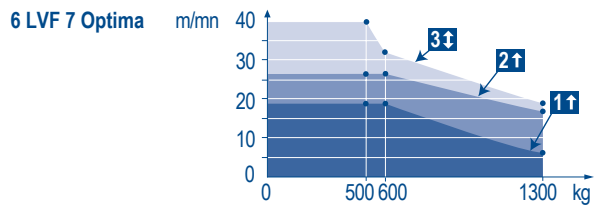

Montage
Montage
Erection
Montaje
Montaggio
Montagem

MBK 2

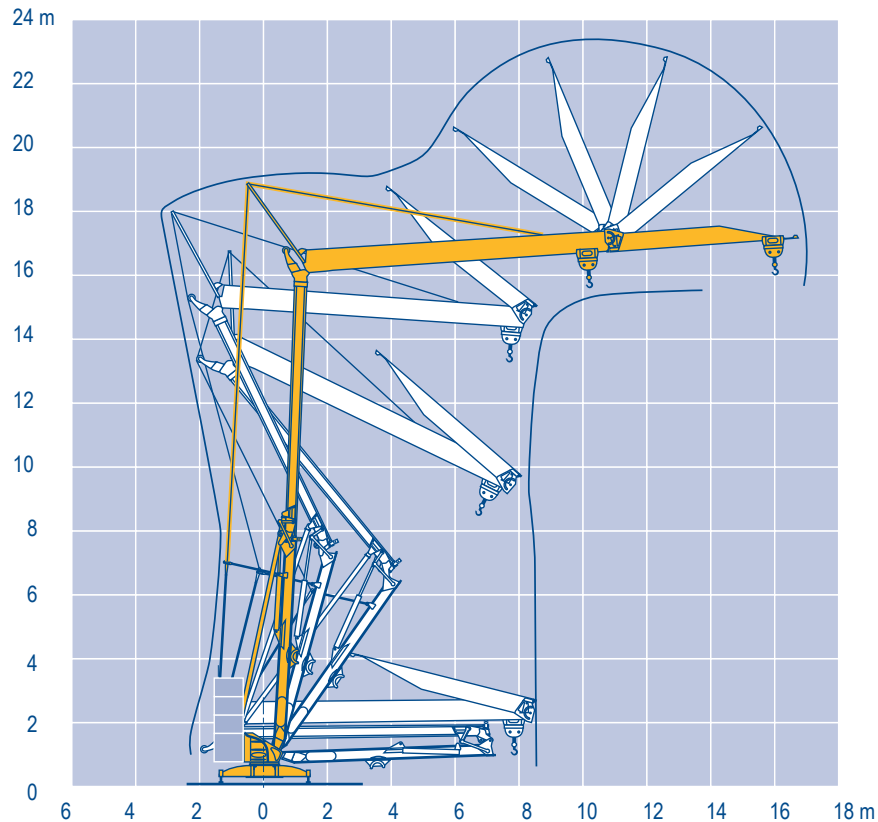

Igo 10

POTAIN 

F	D	GB	E	I	P
					
Levage	Heben	Hoisting	Elevación	Sollevamento	Elevação
Distribution	Katzfahren	Trolleying	Distribución	Distribuzione	Distribuição
	Schwenken	Slewing	Orientación	Rotazione	Rotação
	50 Hz Einphasige	50 Hz Single phase	50 Hz Monofasica	50 Hz Monofase	50 Hz monofásica

Transport
Transport
Transport
Transporte
Transporto
Transporte

MBK 3

- DS30/S30 ○
- DS51/S70 ○
- DS61/S80 ○
- DS61/S120 ○
- DS61/S125
- DS65/S65
- DJ80/S120 ○
- DJ80/S125
- DJ100/S120 ○
- DJ105/S125

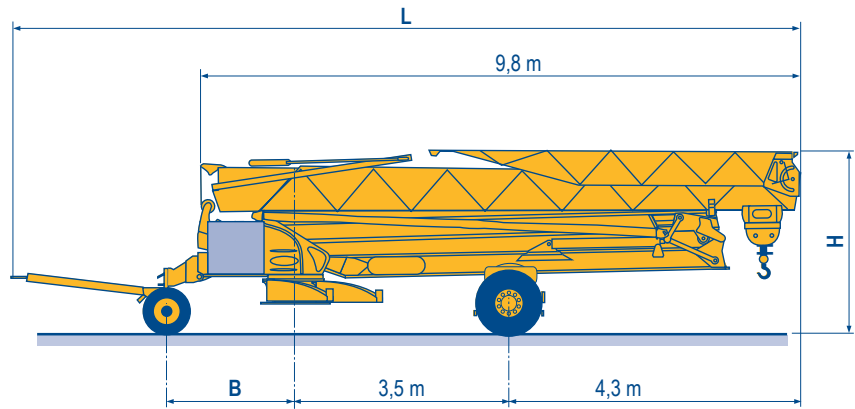
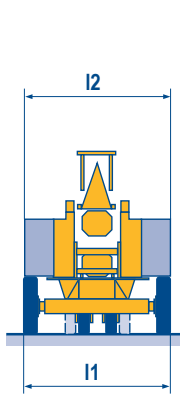

	L (m)	B (m)	H (m)	l1/l2 (m)
DS30/S30	11,46	1,98	2,68	1,73
DS51/S70	12,12	2,32	2,65/2,8	2,1/2,4
DS61/S80	12,4	2,08	2,65/2,8	1,82/2,4
DS61/S120	12,4	2,08	2,65/2,8	2,4
DS61/S125	12,4	2,08	2,65/2,8	2,4
DS65/S65	12,4	1,98	2,65/2,8	1,98/2,4
DJ80/S120	12,4	2,08	2,65/2,8	2,4
DJ80/S125	12,4	2,08	2,65/2,8	2,4
DJ100/S120	12,4	2,08	2,65/2,8	2,4
DJ105/S125	12,4	2,08	2,65/2,8	2,4

- **F**
Chantier
- D**
Baustelle
- GB**
Site
- E**
Obra
- I**
Cantiere
- P**
Estaleiro

Document commercial non contractuel. Pour toute information technique se référer à la notice correspondante. Unverbindliches Vertriebsdokument. Für technische Informationen, siehe die entsprechenden Anweisungen. This commercial document is not legally binding. For any technical information, please refer to the corresponding instructions. Documento comercial no contractuel. Para cualquier información técnica, ver la noticia correspondiente. Documento commerciale non vincolante, per tutte le informazioni tecniche fare riferimento al catalogo istruzioni. Documento comercial não contratual. Para qualquer informação técnica complementar consultar as respectivas instruções.

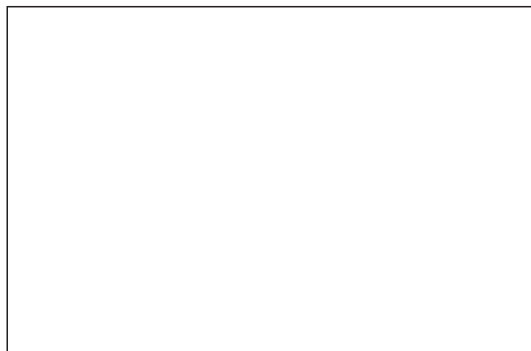

Americas
Tel : +1 888 479 7278
Tel : +1 717 593 2000

Europe – Middle East – Africa
Tel : +33 (0) 4 72 81 50 00
Tel : +44 (0) 191 522 2000

Asia – Pacific
Tel : +65 6264 1188
Fax : +65 6862 4040

www.manitowoccrane.com

**18, rue de Charbonnières - B.R.173
69132 ECULLY Cedex - France**
Tél. : +33 (0) 4 72 18 20 20
Fax. : +33 (0) 4 72 18 20 00
www.manitowoccrane.com

Igo 10
Code B-89985-21_Réf. 2004 38 MBK 7

Copyright.Reproduction interdite © POTAIN 2004

Réalisation Secloc