

GTMR 380B

POTAIN 

POTAIN GTMR 380B

Cotes Abmessungen Dimensions Dimensiones

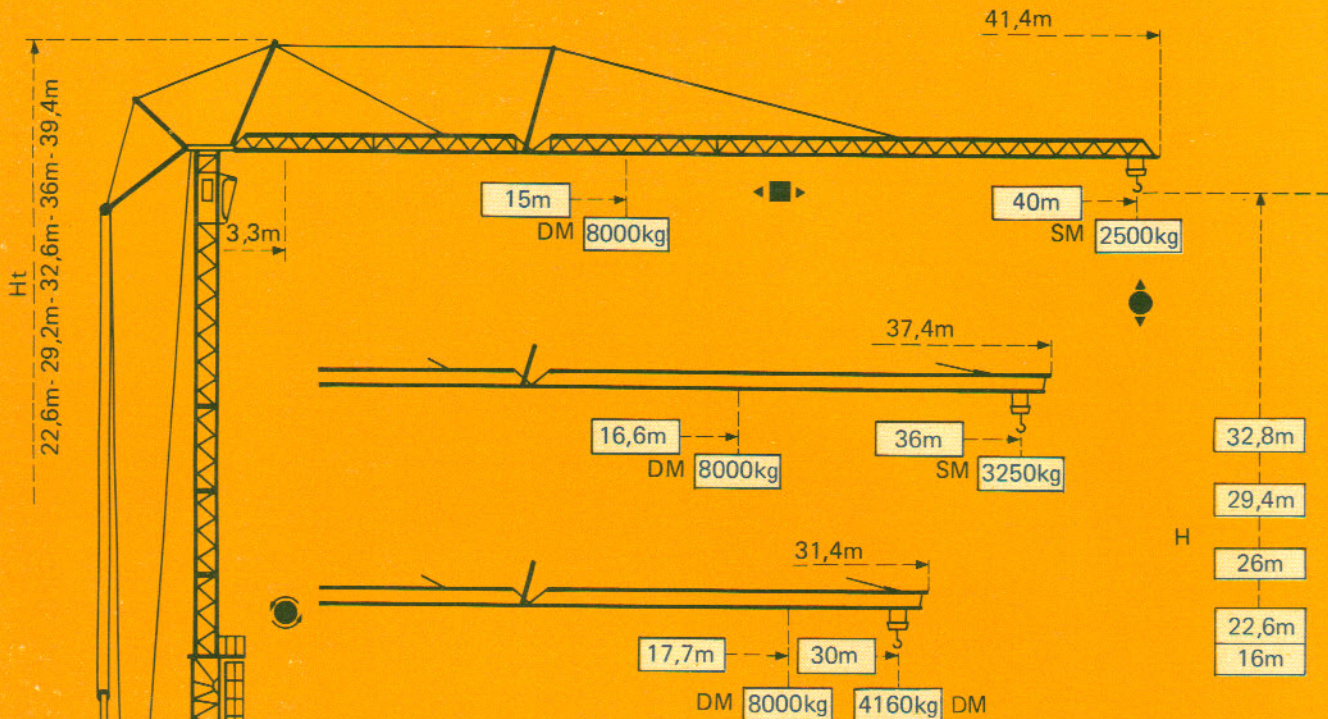

Version sur vérins
Ausführung auf Abstützspindeln
Jacks version
Versión sobre gatos

Version voie droite
Ausführung gerade Schienenbahn
Straight track version
Versión vía recta

Version voie courbe
Ausführung Kurvengleis
Curved track version
Versión vía curva

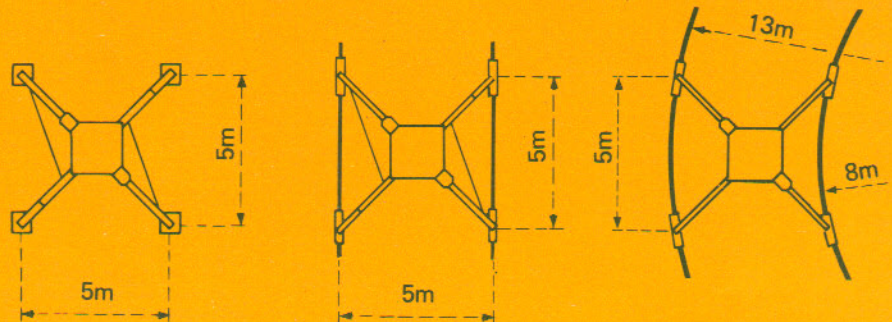

F1 = Réactions Eckdrücke Reactions Reacciones

F1	● 415kN	■ 257kN
	28,75t	

- En service
- Hors service

 A vide sans lest ni train de transport, avec flèche et hauteur maximum.

- In Betrieb
- Ausser Betrieb

 Ohne Last, Ballast und Transportachse, mit Maximalausleger und Maximalhöhe.

- In service
- Out of service

 Without load, ballast or transport axles, with maximum jib and maximum height.



- En servicio
- Fuera de servicio

 Sin carga, sin lastre, ni tren de transporte, flecha y altura maximas.



Courbes de charges Lastkurven Load diagram Curvas de cargas

 Flèche Ausleger Jib Flecha

3,3 →	15	16	18	20	22	24	26	28	30	32	34	36	38	40	m
	8000	7400	6370	5580	4950	4430	4000	3630	3320	3050	2810	2600	2420	2250	kg

40m 																
	3,3 →															
	27	28	30	32	34	36	38	40	m							
								4000	3850	3540	3280	3050	2840	2660	2500	kg

3,3 →	16,6	18	20	22	24	26	28	30	32	34	36	m	
	8000	7230	6340	5630	5040	4560	4150	3800	3500	3230	3000	kg	

36m 														
	3,3 →													
	30,2	32	34	36	m									
					4000	3740	3480	3250	kg					







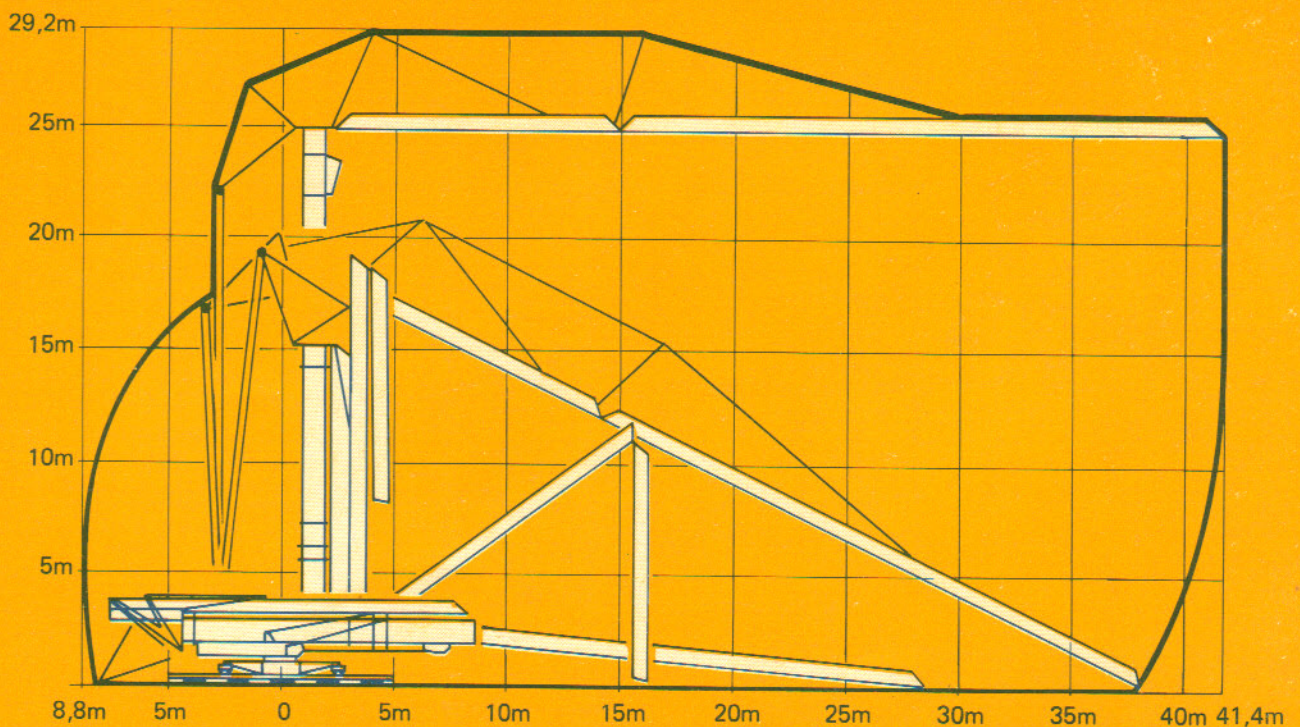







3,3 →	17,7	18	20	22	24	26	28	30	m	
	8000	7850	6890	6130	5500	4980	4540	4160	kg	

30m 														
	3,3 →													
	30	m												
									4000	kg				

Montage Montage Erection Montaje



Mécanismes Antriebe Mechanisms Mecanismos

				m/min.	kg	ch-PS hp	kW
Levage Heben Hoisting Elevación	 33PC20 			5,5	4000	5,5	4
				30	4000	33	24
				60	2000		
				2,7	8000	5,5	4
				15	8000	33	24
				30	4000		
Distribution - <i>Katzfahren</i> Trolleying - <i>Distribución</i>		RCC 52	15 30 45		6,5	4,8	
Orientation - <i>Schwenken</i> Slewing - <i>Orientación</i>		RCO 37	0,12-0,4-0,8 tr/min U/min-rpm		2 x 4	2 x 3	
Translation - <i>Kranfahren</i> Travelling - <i>Traslación</i>		TB 124	25		2 x 4	2 x 3	
Puissance électrique nécessaire Anschlusswert Necessary electric power Potencia eléctrica necesaria	380 V 50 HZ 	Réseau - <i>Netzstrom</i> - Mains supply - <i>Red</i>			50 kVA		
		Groupe électrogène - <i>Stromaggregat</i> Generator set - <i>Grupo eléctrico</i>			Nous consulter <i>Auf Anfrage</i> Consult us <i>Consultarnos</i>		

Transport Transport Transport Transporte

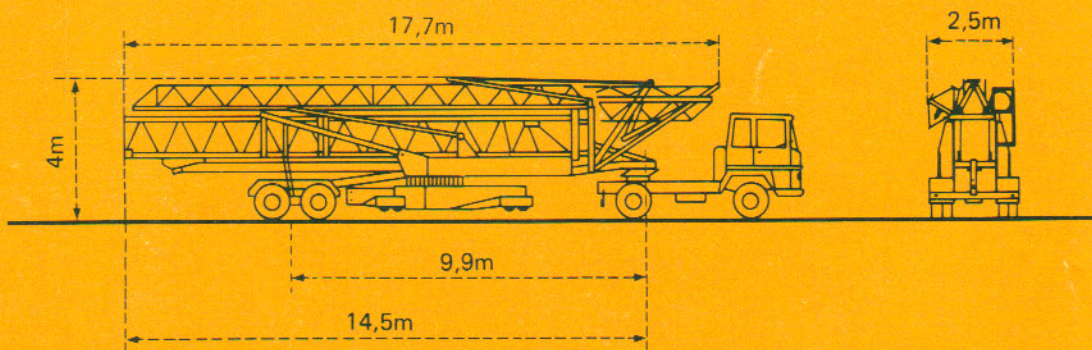

Version semi-portée
 Ausführung als Sattelauflieger
 Tractor towed version
 Versión en semi-remolque

POTAIN 

18, rue de Charbonnières B.P 173 - F 69132 ECULLY Cedex
 Tél. (7) 833.81.81 - Télex 330 179
 DIRECTION DES ACTIVITES INTERNATIONALES
 207, rue de Bercy - F 75012 PARIS
 Tél. (1) 347.30.77 - Télex 215 483
 POTAIN GmbH - D 6082 MÖRFELDEN - WALLDORF
 Nordendstr. 79-87 - Postfach 420 - Tel. 06105 704.0 - Telex 4.185745
 POTAIN SUISSE S.A - CH 5115 MORIKEN WILDEGG
 Tel. 64.53.19.91 - Telex 68294

Modifications réservées - Änderungen vorbehalten - Subject to modification - Modificaciones reservadas
 Printed in France