

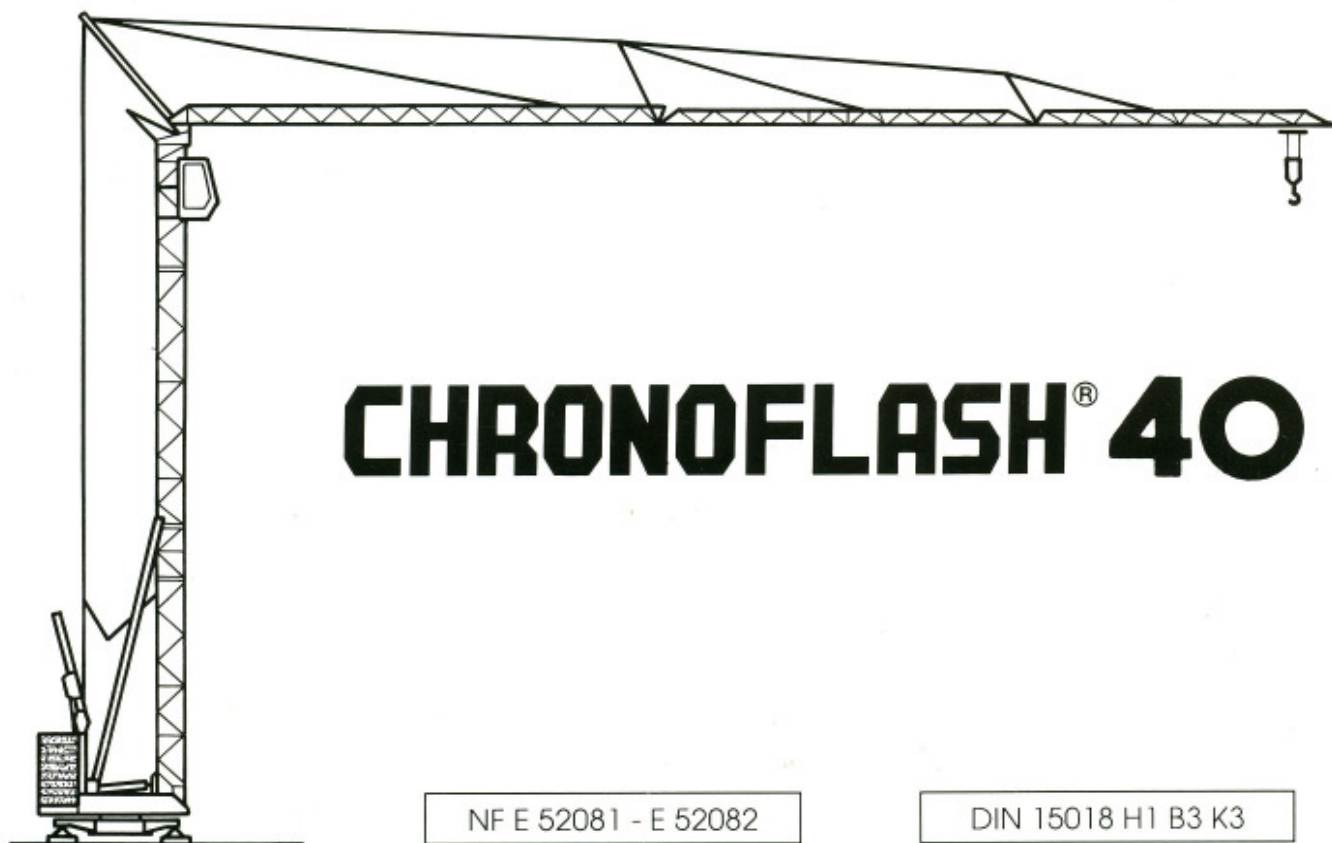

BPR-Cadillon



CHRONOFLASH[®] 40

NF E 52081 - E 52082

DIN 15018 H1 B3 K3

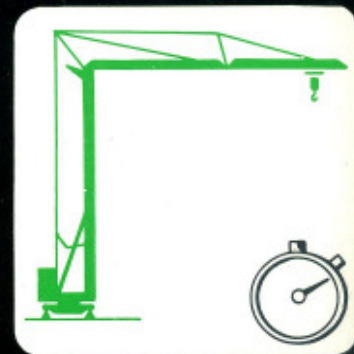
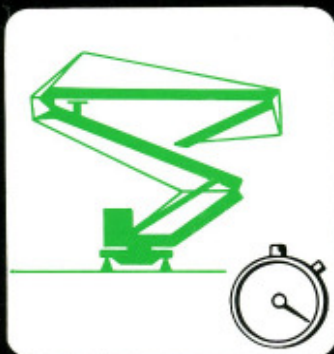

CHRONOFLASH 40

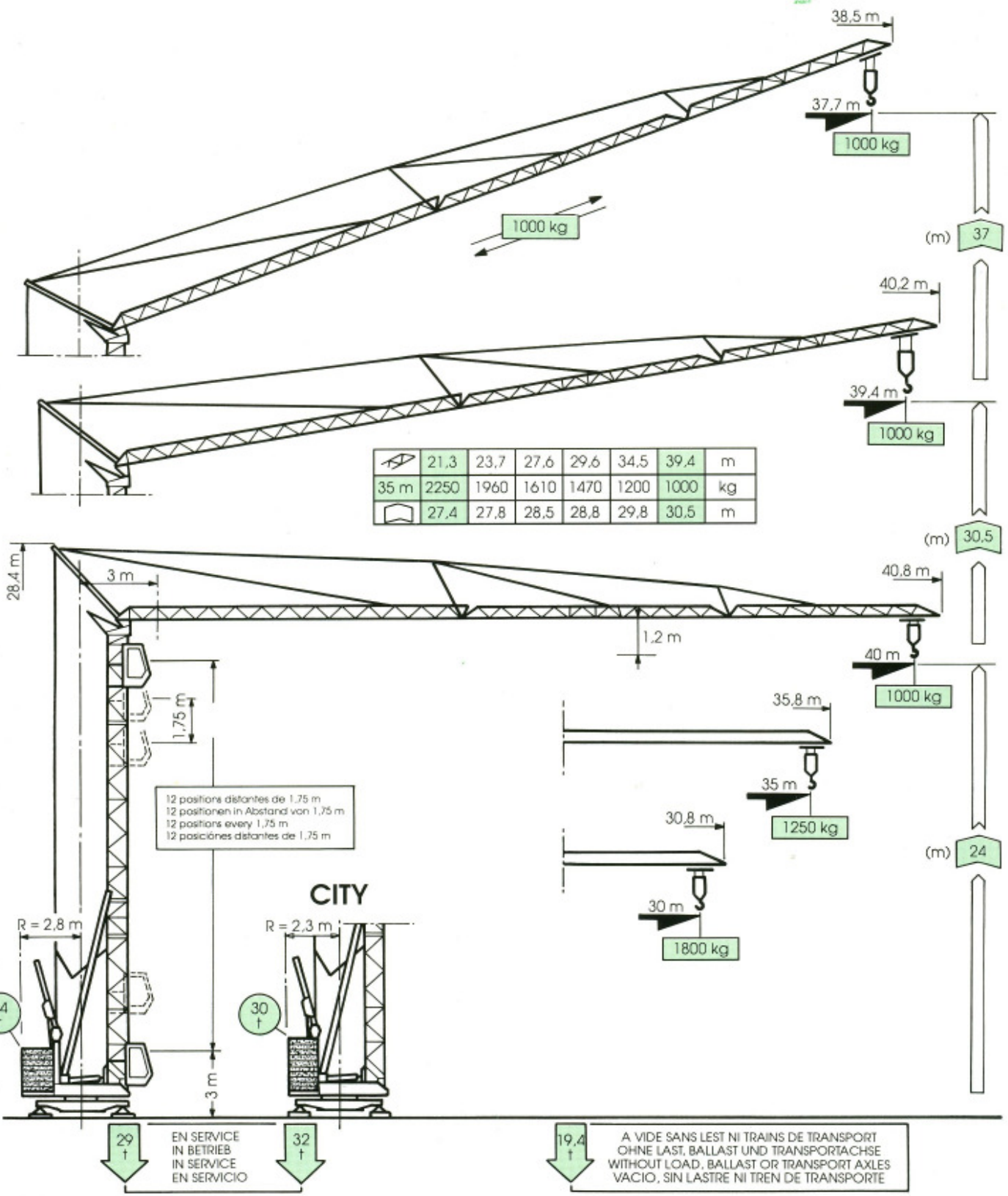

CHRONOFLASH 40

S/D		12.5	12.9	14.4	15	16	18	20	22	24	26	28	30	33	35	38	40
	40 m	4500	4350	3750	3570	3290	2830	2480	2190	1960	1770	1610	1470	1300	1200	1070	1000
	35 m		4500	3890	3700	3410	2930	2570	2280	2040	1840	1670	1530	1350	1250		
	30 m			4500	4280	3950	3410	2990	2660	2380	2160	1960	1800				kg

CHRONOFLASH 40

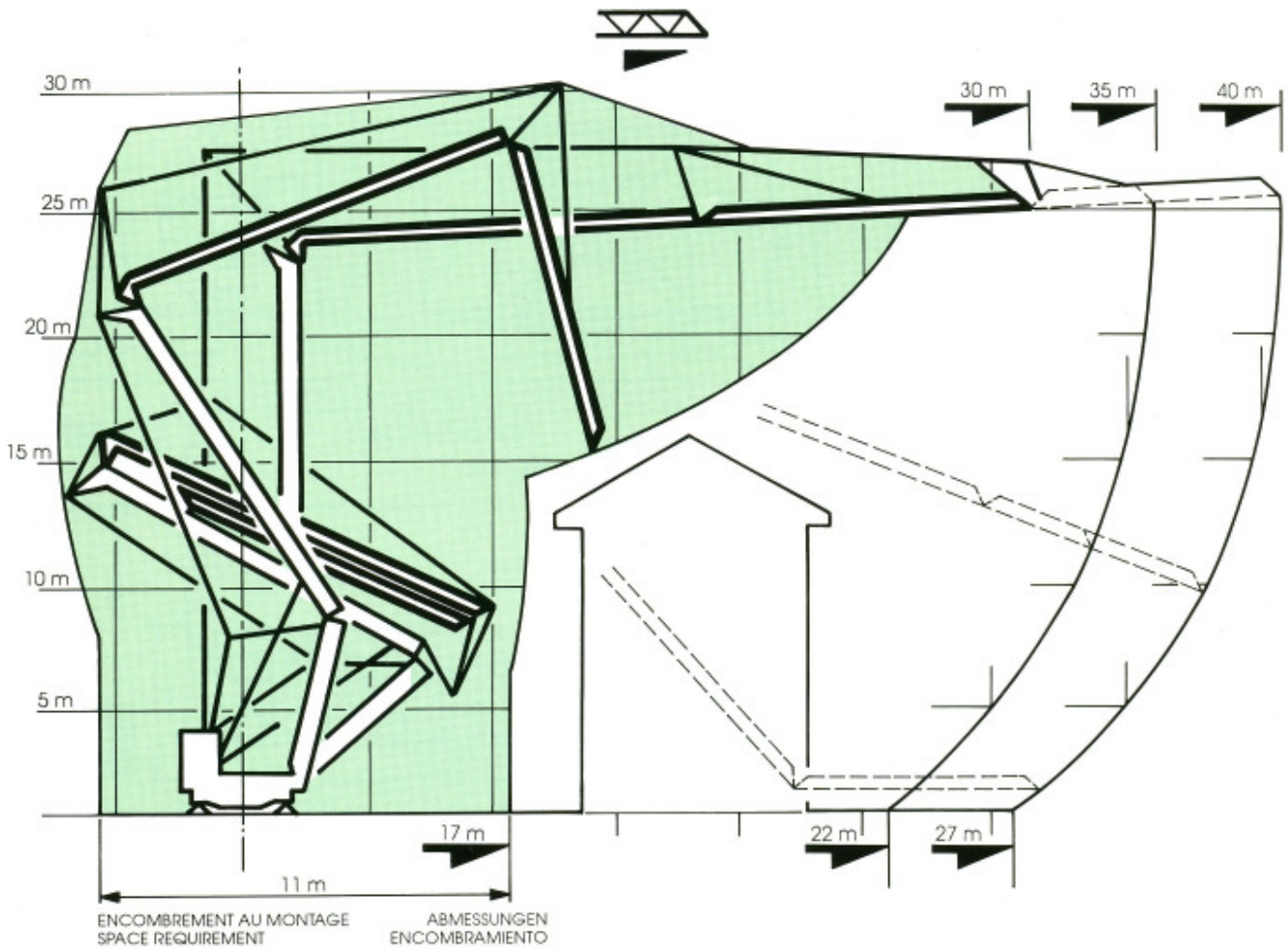

CHRONOFLASH 40		m/mn	KW	ch PS - HP	kg
	I	3	4	5,5	4500
	II	12,5	11	15	4500
	III	25	15	20	3000
	I	6	4	5,5	2250
	II	25	11	15	2250
	III	50	15	20	1500
tr/mn U/mn		0,15 > 0,4 > 0,8	5	6,8	
	I	22,5	4	5,5	
	II	45			
	I	0 > > 25	2 x 2,2	2 x 3	
	II				
			5,5	7,5	

V	380	450
Hz	50	60
kVA	25	30

GROUPE ELECTROGENE STROMAGGREGAT GENERATOR SET GRUPO ELECTROGENO		
V	380	450
Hz	50	60
kVA	60	70

CHRONOFLASH® 40

VERSIONS SUR CHASSIS

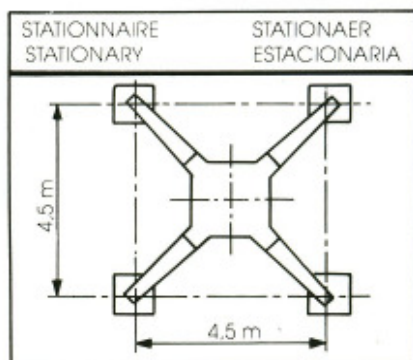

UNTERWAGEN

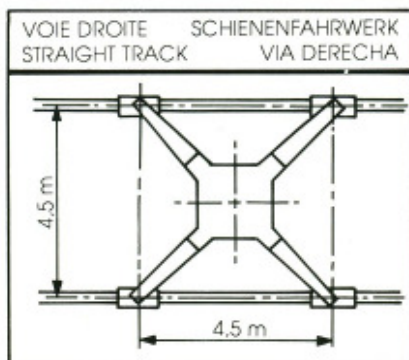

UNDERCARRIAGE

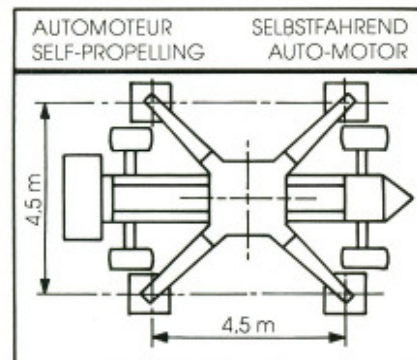

TRANSPORT ROUTIER

TRANSPORT STRASSE

TRANSPORT ROAD

TRANSPORTE RUTA

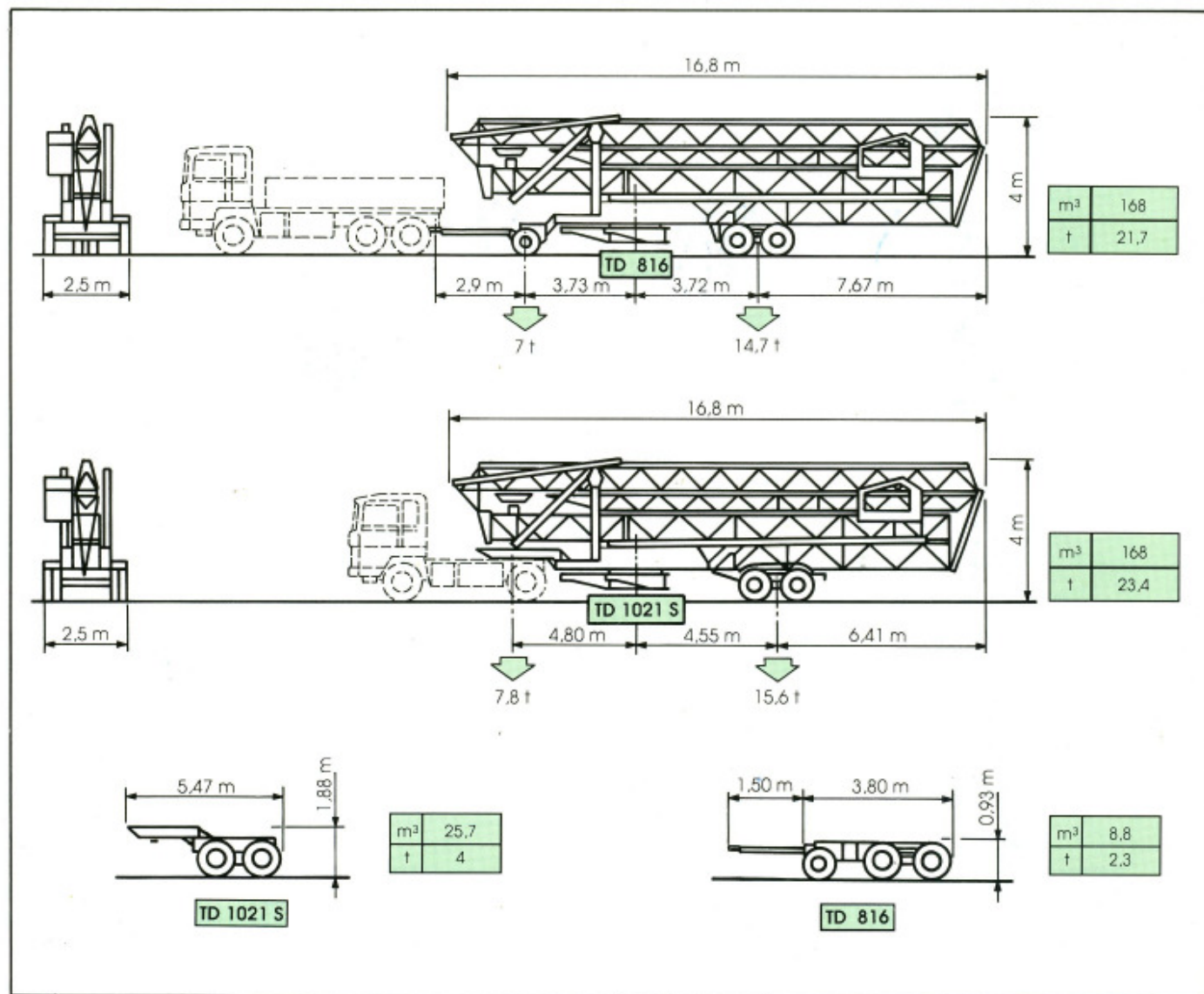

BPR-Cadillon

Siège social : 17, rue de Verdun - BP 28 - 71120 CHAROLLES - France
 Tél. : (33) 85 24 09 34 - Téléx : 800 418 - Fax : (33) 85 88 34 10
 220, avenue de Stalingrad - 94550 CHEVILLY-LARUE - France
 Tél. : (33-1) 45 60 91 48 - Téléx : 260 728 - Fax (33-1) 46 87 80 66
 11, rue de la Ligne de l'Est - BP 1064 - 69613 VILLEURBANNE Cedex
 Tél. : (33) 72 34 99 00 - Téléx : 370 242 - Fax : (33) 72 34 99 20
 CADILLON BAUMASCHINEN G.m.b.H. : Am Dornbusch 4
 D 6108 WEITERSTADT - Tél. 19 49 6151 85041 ou 85042 ou 85043
 Télécopie 19 49 6151 82535 - Téléx 041419223 +

DATA N° 280.29.1190