

Voor "version CITY", contacteer ons. Pour "version CITY", consultez nous. For "version CITY", contact us. Für "version CITY", kontaktieren Sie uns.



ARCOMET
 www.arcomet.com



LASTENTABEL - COURBES DE CHARGES - LOAD CURVES - LASTKURVEN - CURVE DI CARICO - CURVAS DE CARGAS

m	13,52	14	15	16	17	18	19	20	21	22	23	24	25	26	27	28	29	30
kg	4000	3833	3521	3252	3020	2816	2636	2476	2332	2203	2086	1980	1882	1793	1711	1635	1565	1500
ft	44'4"	45'11"	49'3"	52'6"	55'9"	59'1"	62'4"	65'7"	68'11"	72'2"	75'6"	78'9"	82'0"	85'4"	88'7"	91'10"	95'2"	98'5"
lbs	8820	8450	7760	7170	6660	6210	5810	5460	5140	4860	4600	4370	4150	3950	3770	3610	3450	3310

m	14,05	15	16	17	18	19	20	21	22	23	24	25	26	27,5
kg	4000	3691	3411	3168	2955	2767	2599	2449	2314	2192	2081	1979	1886	1760
ft	46'1"	49'3"	52'6"	55'9"	59'1"	62'4"	65'7"	68'11"	72'2"	75'6"	78'9"	82'0"	85'4"	90'3"
lbs	8820	8140	7520	6980	6520	6100	5730	5400	5100	4830	4590	4360	4160	3880

m	14,75	15	16	17	18	19	20	21	22	23	24	25
kg	4000	3904	3608	3352	3128	2930	2753	2595	2453	2324	2207	2100
ft	48'5"	49'3"	52'6"	55'9"	59'1"	62'4"	65'7"	68'11"	72'2"	75'6"	78'9"	82'0"
lbs	8820	8610	7950	7390	6900	6460	6070	5720	5410	5120	4870	4630

m	15,25	16	17	18	19	20	21	22,5
kg	4000	3773	3506	3272	3066	2882	2717	2500
ft	50'0"	52'6"	55'9"	59'1"	62'4"	65'7"	68'11"	73'10"
lbs	8820	8320	7730	7210	6760	6350	5990	5510

m	15,75	16	17	18	19	20
kg	4000	3925	3648	3405	3191	3000
ft	51'8"	52'6"	55'9"	59'1"	62'4"	65'7"
lbs	8820	8650	8040	7510	7040	6610

m	16,29	17,5
kg	4000	3670
ft	53'5"	57'5"
lbs	8820	8090



m	24,81	25	26	27	28	29	30
kg	2000	1982	1893	1811	1735	1665	1600
ft	81'5"	82'0"	85'4"	88'7"	91'10"	95'2"	98'5"
lbs	4410	4370	4170	3990	3830	3670	3530

HOEKDRUKKEN - RÉACTIONS - REACTIONS - ECKDRÜCKE - REAZIONI - REACCIONES



	kN	235
	kips	53



	kN	175
	kips	39



	kg	13 800
	lbs	30 420

AANDRIJVINGEN - MÉCHANISMES - MECHANISMS - ANTRIEBE - MECCANISMI - MECANISMOS



max. 2000 kg







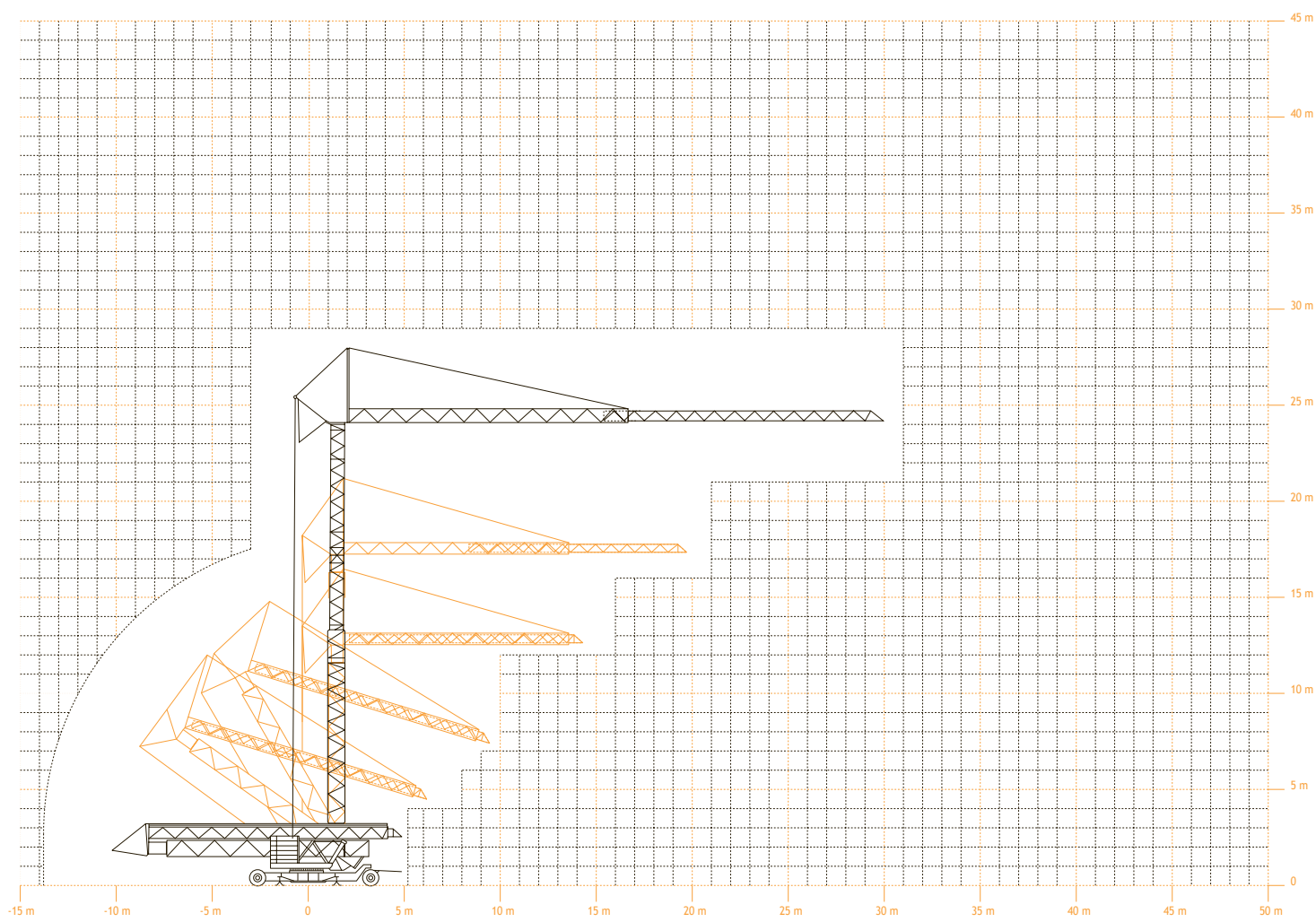



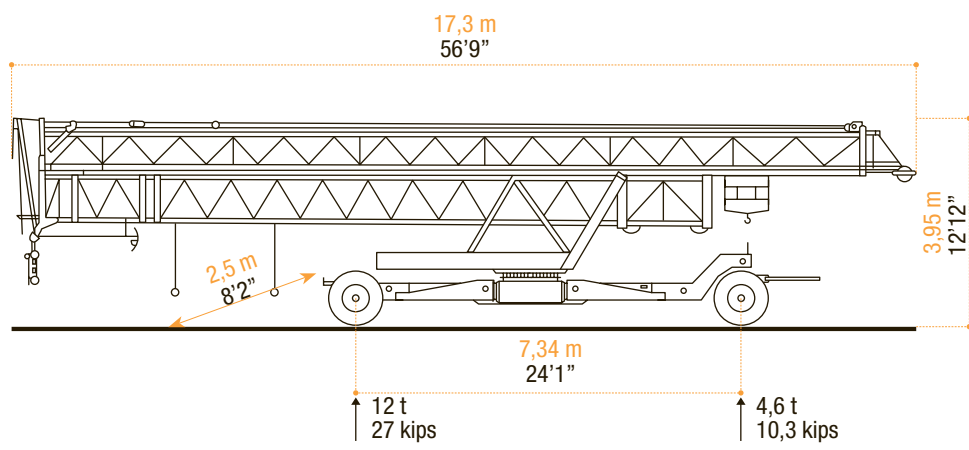









max. 4000 kg

VEREISTE MONTAGERUIMTE - ENCOMBREMENT AU MONTAGE - SPACE REQUIREMENT - ABMESSUNGEN - SPAZIO NECESSARIO PER IL MONTAGGIO



TRANSPORT



 <ul style="list-style-type: none"> • in bedrijf • en service • in service • in Betrieb • in servizio • en servicio 	 <ul style="list-style-type: none"> • buiten bedrijf • hors service • out of service • außer Betrieb • fuori servizio • fuera de servicio 	 <ul style="list-style-type: none"> • hijsen • levage • hoisting • heben • sollevamento • elevación 	 <ul style="list-style-type: none"> • loopkatrijden • chariotage • jib trolleying • Katzfahren • traslazione carrello • poleas móviles 	 <ul style="list-style-type: none"> • zwenken • orientation • slewing • Schwenken • rotazione • orientación 	 <ul style="list-style-type: none"> • spanning • tension • voltage • spannung • tensione • tensión 	 <ul style="list-style-type: none"> • gewicht zonder ballast • poids propre sans lest • weight without ballast • gewicht ohne Ballast • peso senza zavorra • peso sin lastre
 <ul style="list-style-type: none"> • lengte • longueur • length • länge • lunghezza • longitud 	 <ul style="list-style-type: none"> • spoor • translation • rail • Kranfahren • carreggiata • rail 	 <ul style="list-style-type: none"> • vermogen • puissance • power • leistung • potenza • potencia 	 <ul style="list-style-type: none"> • micro snelheid • vitesse • speed • Geschwindigkeit • velocità • velocidad 	 <ul style="list-style-type: none"> • 2^e snelheid • 2^e vitesse • 2^e speed • 2^e Geschwindigkeit • 2^e velocità • 2^e velocidad 	 <ul style="list-style-type: none"> • 3^e snelheid • 3^e vitesse • 3^e speed • 3^e Geschwindigkeit • 3^e velocità • 3^e velocidad 	 <ul style="list-style-type: none"> • maximale hoekdruk • réactions • reactions • Eckdrücke : 10 kN = 1t • press. angolare massima • presión angular máxima
 <ul style="list-style-type: none"> • enkel inschering zonder hijsblok • simple mouflage sans moufle • 2 fall reeving without houstingblock • 2 Fach Einsicherung ohne Hakenflasche • passaggio semplice senza paranca • solamente elevación sin polea 	 <ul style="list-style-type: none"> • enkel inschering met hijsblok • simple mouflage avec moufle • 2 fall reeving with houstingblock • 2 Fach Einsicherung mit Hakenflasche • passaggio semplice con paranca • solamente elevación con polea 	 <ul style="list-style-type: none"> • dubbel inschering • double mouflage • 4 fall reeving • 4 Fach Einsicherung • passaggio doppio • elevación doble 				

Konform richtlijn 2000/14/EG betreffende geluidsemissie van materieel voor gebruik buitenshuis en wijzigingen. - également conforme aux dispositions de la directive "émission sonores des équipements utilisés à l'extérieur des bâtiments" 2000/14/CE et aux législations la transposant. - Requirements of directive 2000/14/CE "noise emission in the environment by equipment for use outdoors, as amended. - Bestimmung der Richtlinie "Lärmübertragung des ausserhalb der Gebäude benutzten Ausrüstungen" 2000/14/EG und den gesetzlichen Vorschriften.



ARCOMET

Industrieweg 139 - 3583 Paal-Beringen - BELGIUM - T +32 (0)11 450 950 - EMAIL arcomet@arcomet.com - www.arcomet.com