













F1	In bedrijf - En service - In service - In Betrieb - En servicio	154 kN •
	Buiten bedrijf - Hors service - Out of service - Ausser Betrieb - Fuera de servicio	118 kN •

• 10 kN ≙ 1t

		m/min	kg	kW			
  9 kW		5	2000		30 m/min	1.5	 220 - 380V / 50 Hz 19 kVA
		22.5	2000		0 → 1 rpm U/min	2.2	
		45	1000		25 m/min	2 x 1	 ca. 9600 kg 35 kVA
		5	2000		- zonder ballast - zonder transportstel - sans lest, sans train - without ballast - without towing axle - ohne Ballast, ohne Transportachse - sin lastre, ni tren de transporte		



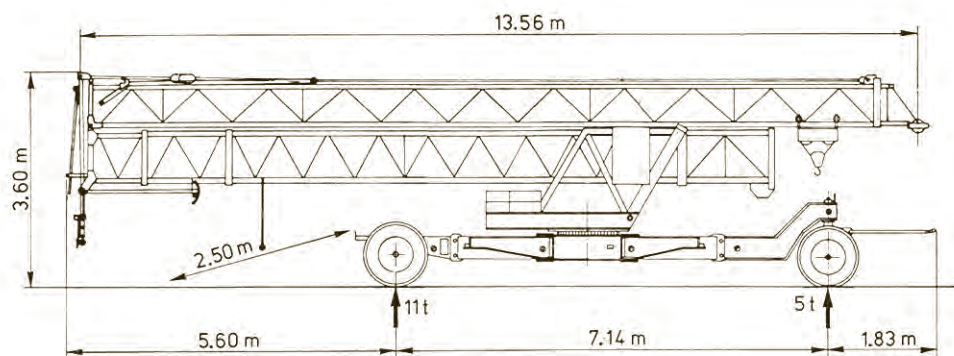
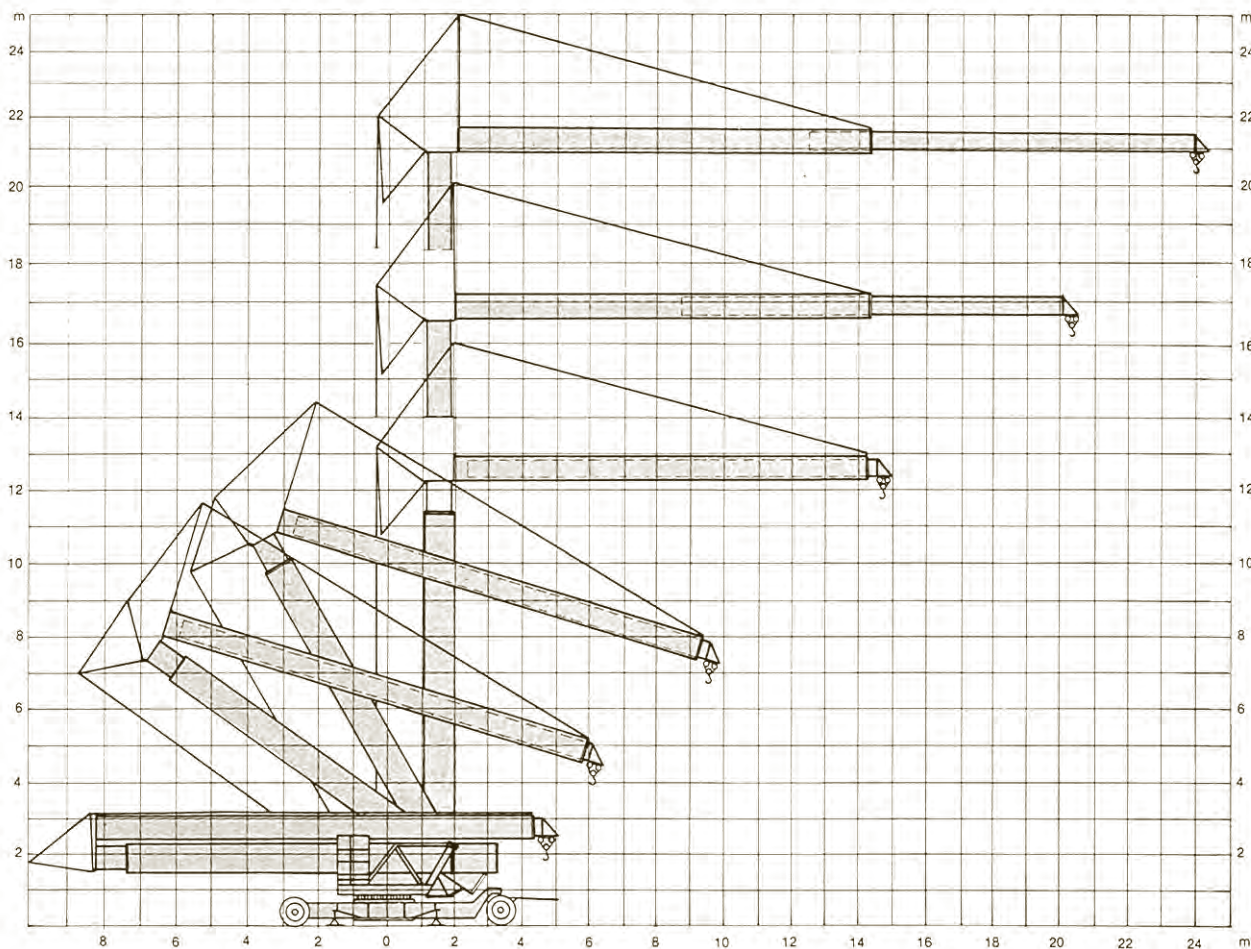

ARCOMET

Industrieweg 139 - 3583 Paal-Beringen - BELGIUM - T +32 (0)11 450 950 - EMAIL arcomet@arcomet.com - www.arcomet.com