



LASTENTABEL - COURBES DE CHARGES - LOAD CURVES - LASTKURVEN - CURVE DI CARICO - CURVAS DE CARGAS

m	2,20 - 14,41	16	19	22	25	28	31	33	36	38	42	45
kg	5000	4420	3616	3047	2625	2298	2038	1892	1705	1598	1415	1300
ft	7'3" - 47'3"	52'6"	62'4"	72'2"	82'0"	91'10"	101'8"	108'3"	118'1"	124'8"	137'10"	147'8"
lbs	11 020	9740	7970	6720	5790	5070	4490	4170	3760	3520	3120	2870

m	2,20 - 15,06	16	19	22	25	28	31	33	36	38	42
kg	5000	4660	3813	3215	2771	2428	2155	2002	1805	1692	1500
ft	7'3" - 49'5"	52'6"	62'4"	72'2"	82'0"	91'10"	101'8"	108'3"	118'1"	124'8"	137'10"
lbs	11 020	10 270	8410	7090	6110	5350	4750	4410	3980	3730	3310

m	2,20 - 15,46	16	19	22	25	28	31	33	36	38
kg	5000	4805	3934	3318	2861	2507	2226	2068	1866	1750
ft	7'3" - 50'9"	52'6"	62'4"	72'2"	82'0"	91'10"	101'8"	108'3"	118'1"	124'8"
lbs	11 020	10 590	8670	7320	6310	5503	4910	4560	4110	3860

m	2,20 - 15,95	16	22	25	28	31	33
kg	5000	4983	3444	2970	2604	2313	2150
ft	7'3" - 52'4"	52'6"	72'2"	82'0"	91'10"	101'8"	108'3"
lbs	11 020	10 990	7590	6550	5740	5100	4740



m	2,20 - 26,51	30	32	34	36	38	42	45
kg	2500	2169	2013	1876	1755	1648	1465	1350
ft	7'3" - 86'12"	98'5"	104'12"	111'7"	118'1"	124'8"	137'10"	147'8"
lbs	5510	4780	4440	4140	3870	3630	3230	2980

HOEKDRUKKEN - RÉACTIONS - REACTIONS - ECKDRÜCKE - REAZIONI - REACCIONES



m	45	291	kN
ft	147'8"	65	kips
	42	291	
	137'10"	65	
	38	285	
	124'8"	64	
	33	274	
	108'3"	62	



m	45	236	kN
ft	147'8"	53	kips
	42	226	
	137'10"	51	
	38	213	
	124'8"	48	
	33	193	
	108'3"	43	



kg	18 200
lbs	40 120

AANDRIJVINGEN - MÉCHANISMES - MECHANISMS - ANTRIEBE - MECCANISMI - MECANISMOS







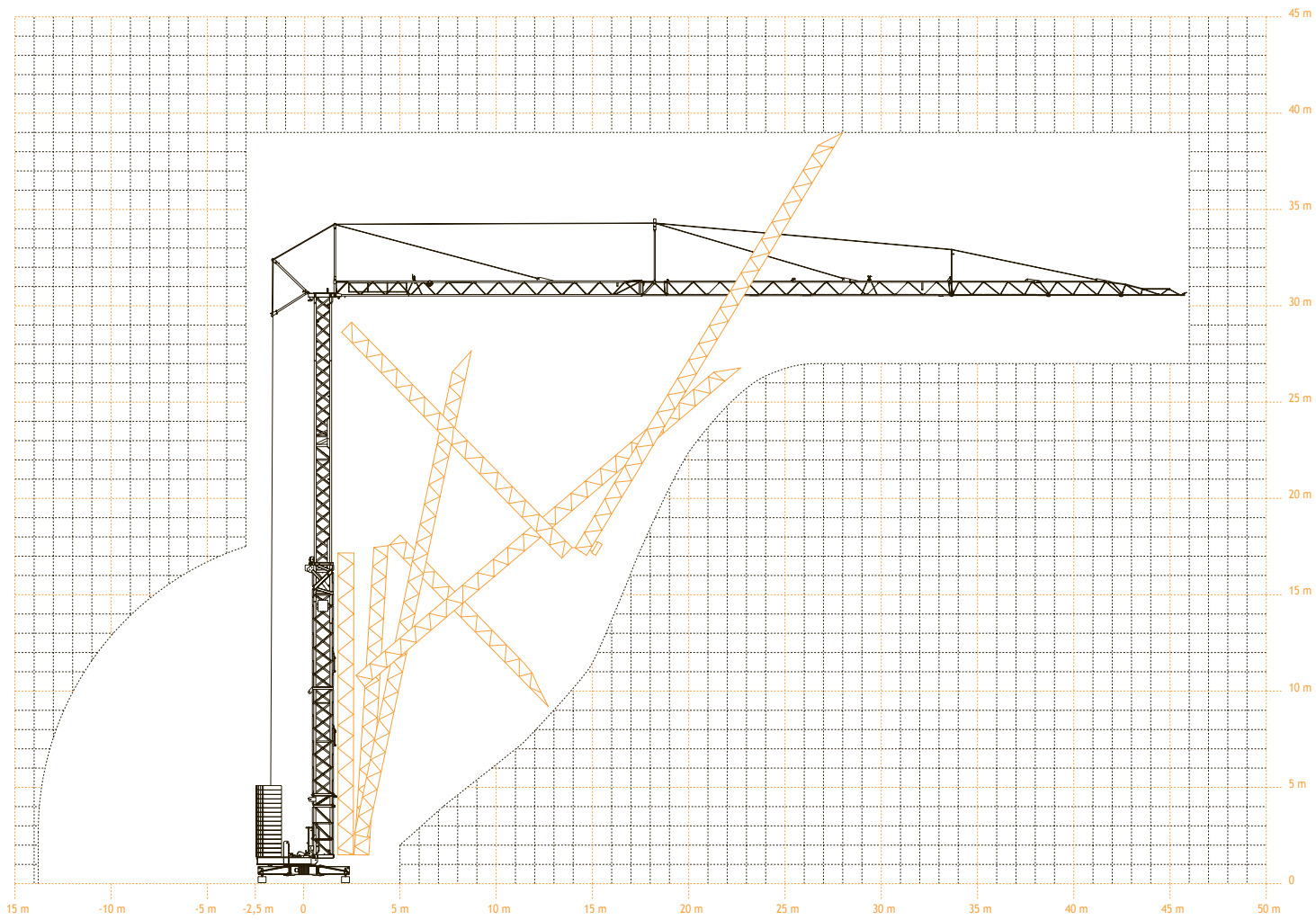



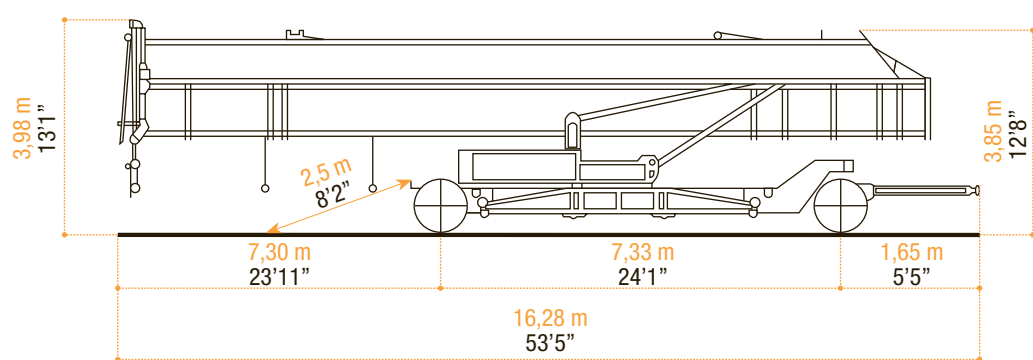









	max. 2500 kg			max. 5000 kg			
	m/min	6,0	25,0	50,0	3,0	12,5	25,0
	kg	2500	2500	1400	5000	5000	2800
	fpm	20	82	164	10	41	82
	lbs	5510	5510	3090	11 020	11 020	6170
	kW	2,4	15,0	15,0	2,4	15,0	15,0
	HP	~3,2	~20,1	~20,1	~3,2	~20,1	~20,1
	m/min	25 / 50		5,5 kW	25 / 50		5,5 kW
	fpm	~82 / 164		~7,4 HP	~82 / 164		~7,4 HP
	tr/min	0 - 0,8		4,8 kW	0 - 0,8		4,8 kW
				~6,4 HP			~6,4 HP
	m/min	25		2 x 1,5 kW	25		2 x 1,5 kW
	fpm	82		~2 x 2 HP	82		~2 x 2 HP
	kVA	32					
		380 V - 50 Hz					

VEREISTE MONTAGERUIMTE - ENCOMBREMENT AU MONTAGE - SPACE REQUIREMENT - ABMESSUNGEN - SPAZIO NECESSARIO PER IL MONTAGGIO



TRANSPORT



 <ul style="list-style-type: none"> • in bedrijf • en service • in service • in Betrieb • in servizio • en servicio 	 <ul style="list-style-type: none"> • buiten bedrijf • hors service • out of service • außer Betrieb • fuori servizio • fuera de servicio 	 <ul style="list-style-type: none"> • hijsen • levage • hoisting • heben • sollevamento • elevación 	 <ul style="list-style-type: none"> • loopkatrjden • chariotage • jib trolleying • Katzfahren • traslazione carrello • poleas móviles 	 <ul style="list-style-type: none"> • zwenken • orientation • slewing • Schwenken • rotazione • orientación 	 <ul style="list-style-type: none"> • spanning • tension • voltage • spannung • tensione • tensión 	 <ul style="list-style-type: none"> • gewicht zonder ballast • poids propre sans lest • weight without ballast • gewicht ohne Ballast • peso senza zavorra • peso sin lastre
 <ul style="list-style-type: none"> • lengte • longueur • length • länge • lunghezza • longitud 	 <ul style="list-style-type: none"> • spoor • translation • rail • Kranfahren • carreggiata • rail 	 <ul style="list-style-type: none"> • vermogen • puissance • power • leistung • potenza • potencia 	 <ul style="list-style-type: none"> • micro snelheid • vitesse • speed • Geschwindigkeit • velocità • velocidad 	 <ul style="list-style-type: none"> • 2^o snelheid • 2^o vitesse • 2^o speed • 2^o Geschwindigkeit • 2^o velocità • 2^o velocidad 	 <ul style="list-style-type: none"> • 3^o snelheid • 3^o vitesse • 3^o speed • 3^o Geschwindigkeit • 3^o velocità • 3^o velocidad 	 <ul style="list-style-type: none"> • maximale hoekdruk • réactions • reactions • Eckdrücke : 10 kN = 1t • press. angolare massima • presión angular máxima
 <ul style="list-style-type: none"> • enkel inschering zonder hijsblok • simple mouflage sans moufle • 2 fall reeving without houstingblock • 2 Fach Einsicherung ohne Hakenflasche • passaggio semplice senza paranca • solamente elevación sin polea 	 <ul style="list-style-type: none"> • enkel inschering met hijsblok • simple mouflage avec moufle • 2 fall reeving with houstingblock • 2 Fach Einsicherung mit Hakenflasche • passaggio semplice con paranca • solamente elevación con polea 	 <ul style="list-style-type: none"> • dubbel inschering • double mouflage • 4 fall reeving • 4 Fach Einsicherung • passaggio doppio • elevación doble 				

Konform richtlijn 2000/14/EG betreffende geluidsemissie van materieel voor gebruik buitenshuis en wijzigingen. - également conforme aux dispositions de la directive "émission sonores des équipements utilisés à l'extérieur des bâtiments" 2000/14/CE et aux législations la transposant. - Requirements of directive 2000/14/CE "noise emission in the environment by equipment for use outdoors, as amended. - Bestimmung der Richtlinie "Lärmübertragung des ausserhalb der Gebäude benutzten Ausrüstungen" 2000/14/EG und den gesetzlichen Vorschriften.



ARCOMET

Industrieweg 139 - 3583 Paal-Beringen - BELGIUM - T +32 (0)11 450 950 - EMAIL arcomet@arcomet.com - www.arcomet.com