

ARCOMET

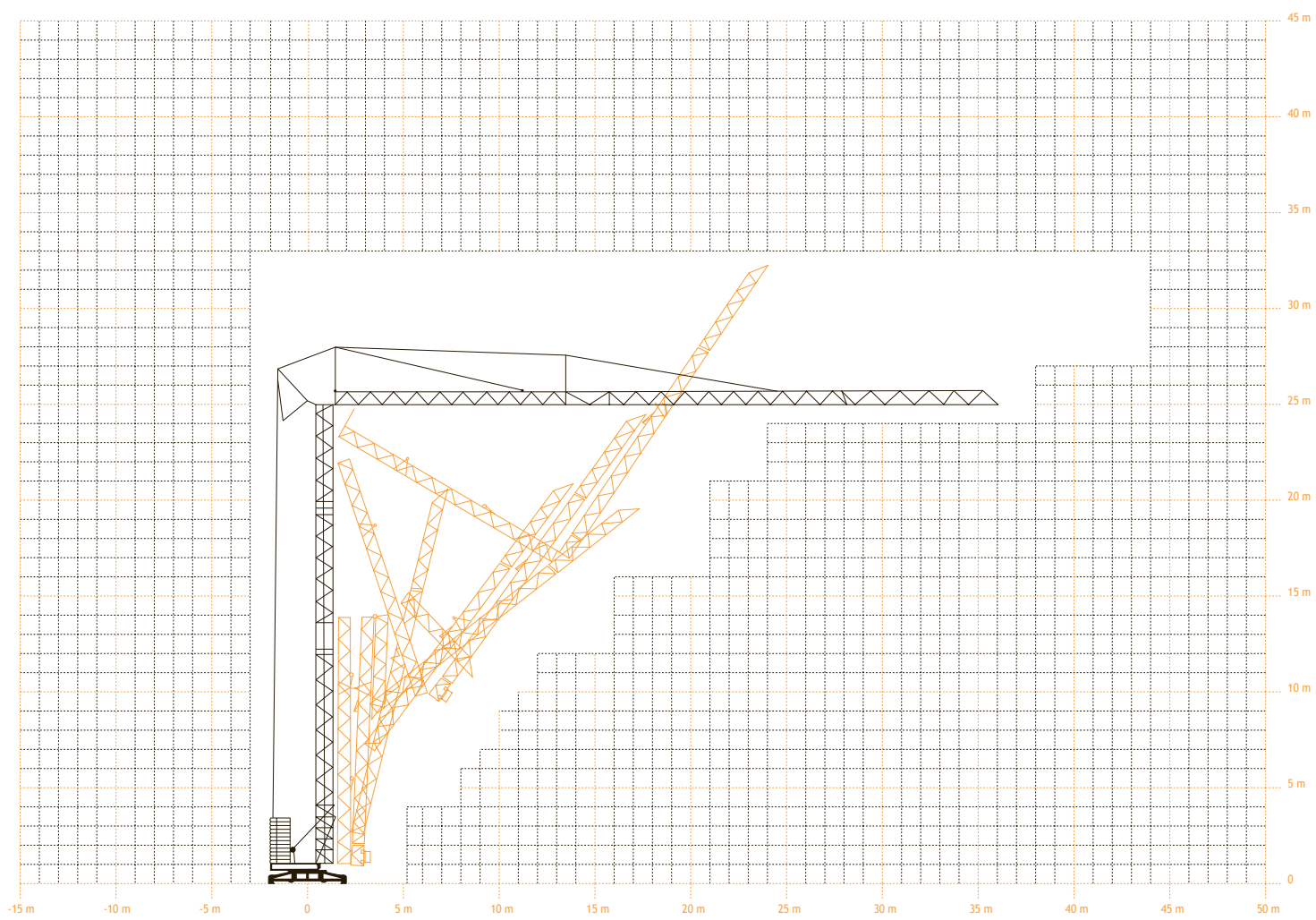







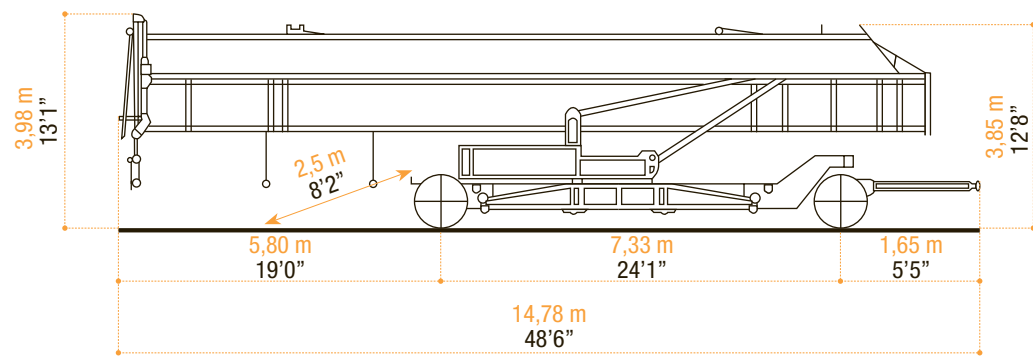







www.arcomet.com

VEREISTE MONTAGERUIMTE - ENCOMBREMENT AU MONTAGE - SPACE REQUIREMENT - ABMESSUNGEN - SPAZIO NECESSARIO PER IL MONTAGGIO



TRANSPORT



 <ul style="list-style-type: none"> • in bedrijf • en service • in service • in Betrieb • in servizio • en servicio 	 <ul style="list-style-type: none"> • buiten bedrijf • hors service • out of service • außer Betrieb • fuori servizio • fuera de servicio 	 <ul style="list-style-type: none"> • hijsen • levage • hoisting • heben • sollevamento • elevación 	 <ul style="list-style-type: none"> • loopkatrijden • chariotage • jib trolleying • Katzfahren • traslazione carrello • poleas móviles 	 <ul style="list-style-type: none"> • zwenken • orientation • slewing • Schwenken • rotazione • orientación 	 <ul style="list-style-type: none"> • spanning • tension • voltage • spannung • tensione • tensión 	 <ul style="list-style-type: none"> • gewicht zonder ballast • poids propre sans lest • weight without ballast • gewicht ohne Ballast • peso senza zavorra • peso sin lastre
 <ul style="list-style-type: none"> • lengte • longueur • length • länge • lunghezza • longitud 	 <ul style="list-style-type: none"> • spoor • translation • rail • Kranfahren • carreggiata • rail 	 <ul style="list-style-type: none"> • vermogen • puissance • power • leistung • potenza • potencia 	 <ul style="list-style-type: none"> • micro snelheid • vitesse • speed • Geschwindigkeit • velocità • velocidad 	 <ul style="list-style-type: none"> • 2^e snelheid • 2^e vitesse • 2^e speed • 2^e Geschwindigkeit • 2^e velocità • 2^e velocidad 	 <ul style="list-style-type: none"> • 3^e snelheid • 3^e vitesse • 3^e speed • 3^e Geschwindigkeit • 3^e velocità • 3^e velocidad 	 <ul style="list-style-type: none"> • maximale hoekdruk • réactions • reactions • Eckdrücke : 10 kN = 1t • press. angolare massima • presión angular máxima
 <ul style="list-style-type: none"> • enkel inschering zonder hijsblok • simple mouflage sans moufle • 2 fall reeving without houstingblock • 2 Fach Einsicherung ohne Hakenflasche • passaggio semplice senza paranca • solamente elevación sin polea 	 <ul style="list-style-type: none"> • enkel inschering met hijsblok • simple mouflage avec moufle • 2 fall reeving with houstingblock • 2 Fach Einsicherung mit Hakenflasche • passaggio semplice con paranca • solamente elevación con polea 	 <ul style="list-style-type: none"> • dubbel inschering • double mouflage • 4 fall reeving • 4 Fach Einsicherung • passaggio doppio • elevación doble 				

Konform richtlijn 2000/14/EG betreffende geluidsemissie van materieel voor gebruik buitenshuis en wijzigingen. - également conforme aux dispositions de la directive "émission sonores des équipements utilisés à l'extérieur des bâtiments" 2000/14/CE et aux législations la transposant. - Requirements of directive 2000/14/CE "noise emission in the environment by equipment for use outdoors, as amended. - Bestimmung der Richtlinie "Lärmübertragung des ausserhalb der Gebäude benutzten Ausrüstungen" 2000/14/EG und den gesetzlichen Vorschriften.



ARCOMET

Industrieweg 139 - 3583 Paal-Beringen - BELGIUM - T +32 (0)11 450 950 - EMAIL arcomet@arcomet.com - www.arcomet.com